

2019 Australian National Championships

Cararra (AUS), 09 Jun 2019

-60 kg

8 Judoka

POOL A

1 KATZ, Josh NSW

9

1 KATZ, Josh

5

13

2

9 KATZ, Josh

Pool A - Winner
Vainqueur / Sieger

POOL B

3 READ, Jacob WA

11

3 READ, Jacob

7 SIMMONS, Nicholas NSW

15

4 SIMMONS, Nicholas

10 READ, Jacob

100 / 000 0:16

Pool B - Winner
Vainqueur / Sieger

POOL C

2 JOLLY, Bryan VIC

10

5 JOLLY, Bryan

6 WILLING, Lewis TAS

14

6 WILLING, Lewis

11 JOLLY, Bryan

100 / 000 0:09

Pool C - Winner
Vainqueur / Sieger

POOL D

4 PAPPAS, Tom VIC

12

7 PAPPAS, Tom

8 ZAHRA, James NSW

16 JONES, Luke QLD

8 ZAHRA, James

010 / 000 s2 4:00

12 PAPPAS, Tom

100 / 000 0:01

Pool D - Winner
Vainqueur / Sieger

KATZ, Josh

100 / 000 0:18

1.

18 PAPPAS, Tom

000 / 010 4:00

Results	
Résultat / Platzierungen	
1. KATZ, Josh	NSW
2. PAPPAS, Tom	VIC
3. JOLLY, Bryan	VIC
3. READ, Jacob	WA
5. SIMMONS, Nicholas	NSW
5. WILLING, Lewis	TAS
7.	
7. ZAHRA, James	NSW

Repechage / Trostrunde

[A1] _____

[A2] _____

[B1] _____

[B2] SIMMONS, Nicholas NSW

13

14 SIMMONS, Nicholas

19 SIMMONS, Nicholas

[18] JOLLY, Bryan

21 JOLLY, Bryan

000 s1 / 100 1:50

3.

[C1] _____

[C2] WILLING, Lewis TAS

[D1] _____

[D2] ZAHRA, James NSW

15 WILLING, Lewis

16 ZAHRA, James

20 WILLING, Lewis

100 / 000 0:00

[17] READ, Jacob

22 READ, Jacob

000 / 100 0:14

3.

2019 Australian National Championships

Cararra (AUS), 09 Jun 2019

-73 kg

24 Judoka

POOL A

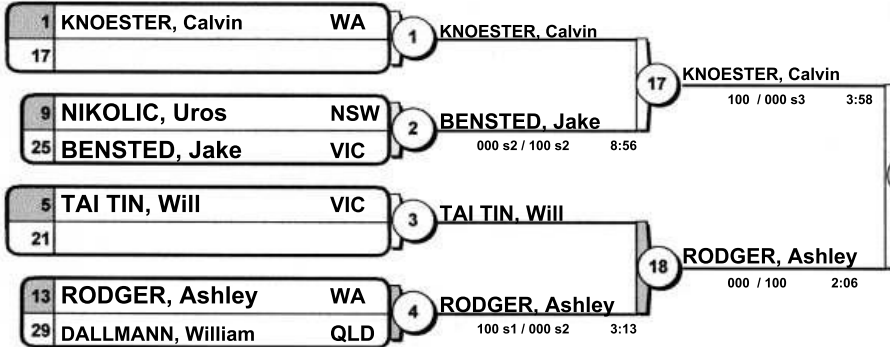

POOL B

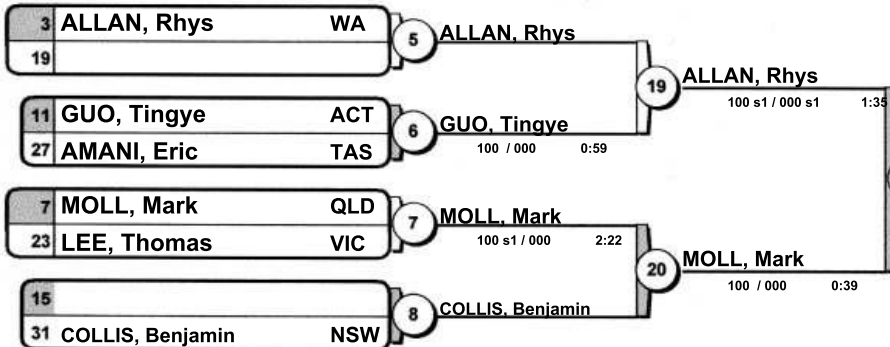

POOL C

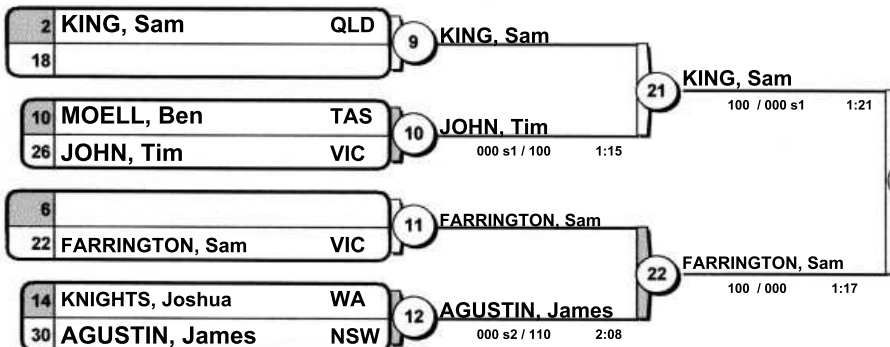

POOL D

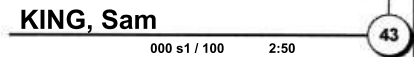

1.

Results

Résultat / Platzierungen

1.	KING, Sam	QLD
2.	KNOESTER, Calvin	WA
3.	BENSTED, Jake	VIC
3.	ALLAN, Rhys	WA
5.	TREDGOLD, Liam	ACT
5.	FARRINGTON, Sam	VIC
7.	GUO, Tingye	ACT
7.	NIGHTINGALE, Noah	VIC

Repechage / Trostrunde

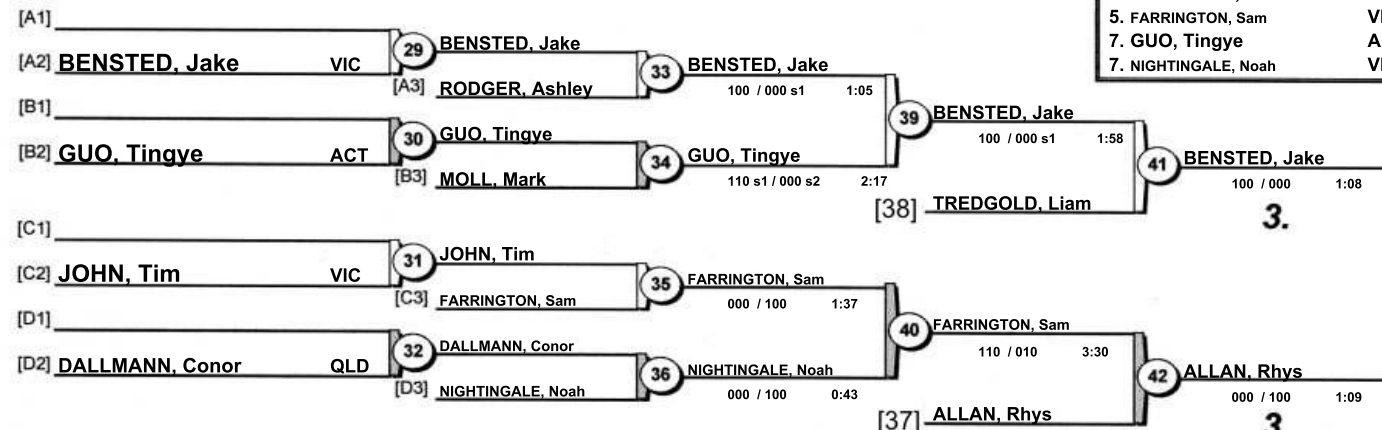

3.

3.

2019 Australian National Championships

Cararra (AUS), 09 Jun 2019

-81 kg

24 Judoka

POOL A

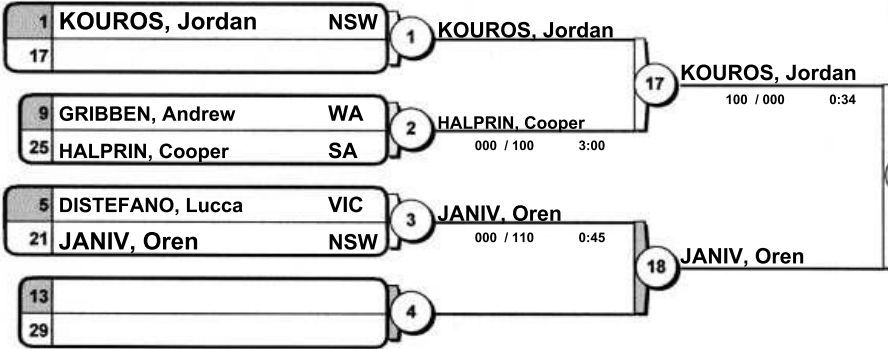

POOL B

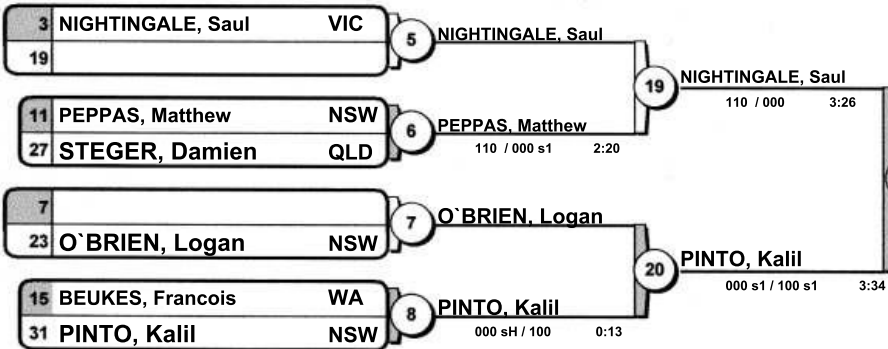

POOL C

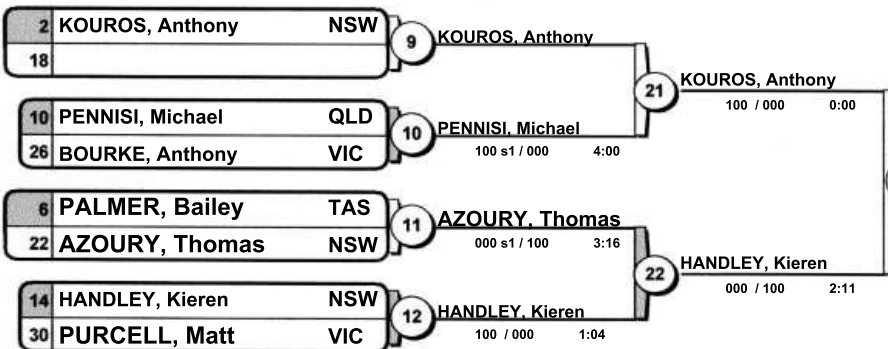

POOL D



1.

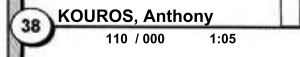

Pool C - Winner
Vainqueur / Sieger

Pool D - Winner
Vainqueur / Sieger

Results
Résultat / Platzierungen

1. KOUROUS, Jordan NSW
2. KOUROUS, Anthony NSW
3. IKI, Rihari WA
3. CONSTANTINIDIS, Fotis NSW
5. JANIV, Oren NSW
5. NIGHTINGALE, Saul VIC
7. PINTO, Kalil NSW
7. PENNISI, Michael QLD

Repechage / Trostrunde

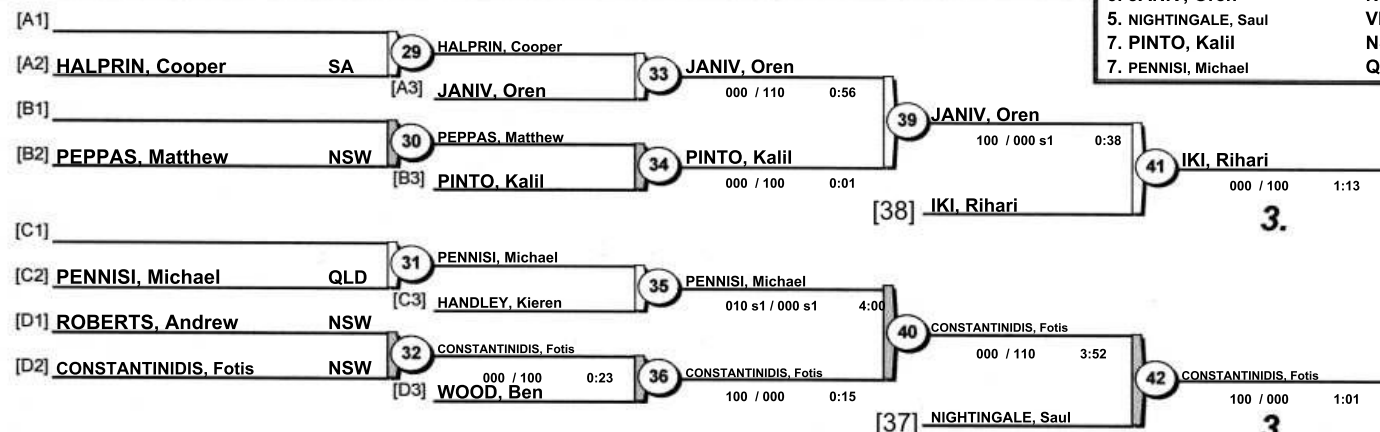

2019 Australian National Championships

Cararra (AUS), 09 Jun 2019

-90 kg

14 Judoka

POOL A

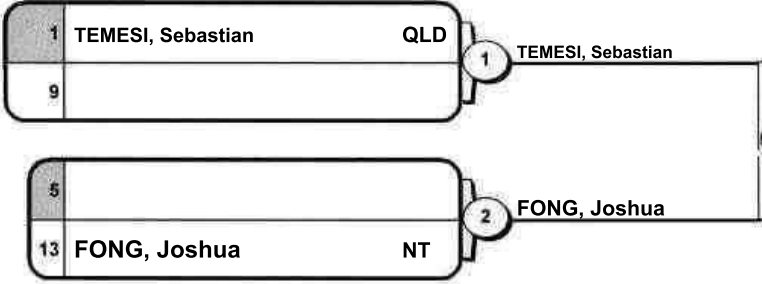

POOL B

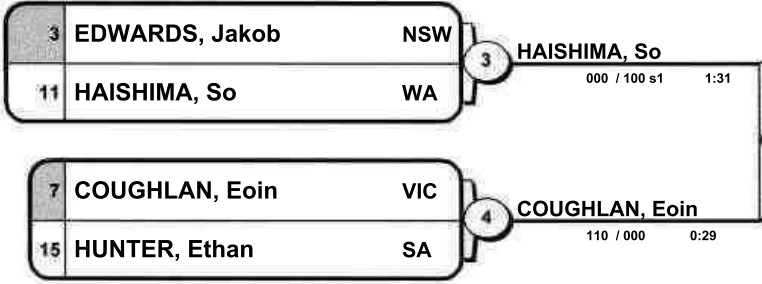

POOL C

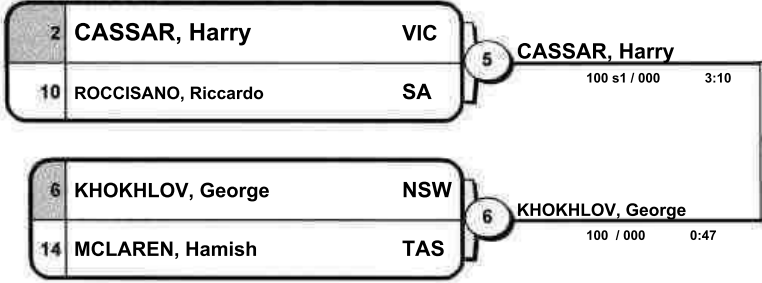

POOL D

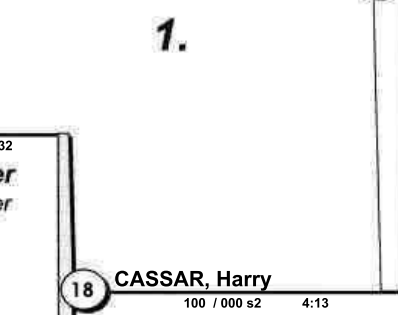
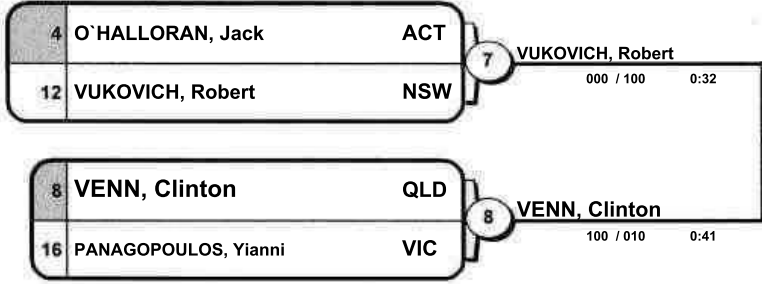

Results	
Résultat / Platzierungen	
1. TEMESI, Sebastian	QLD
2. CASSAR, Harry	VIC
3. VUKOVICH, Robert	NSW
3. COUGHLAN, Eoin	VIC
5. HAISHIMA, So	WA
5. ROCCISANO, Riccardo	SA
7. FONG, Joshua	NT
7. VENN, Clinton	QLD

Repechage / Trostrunde

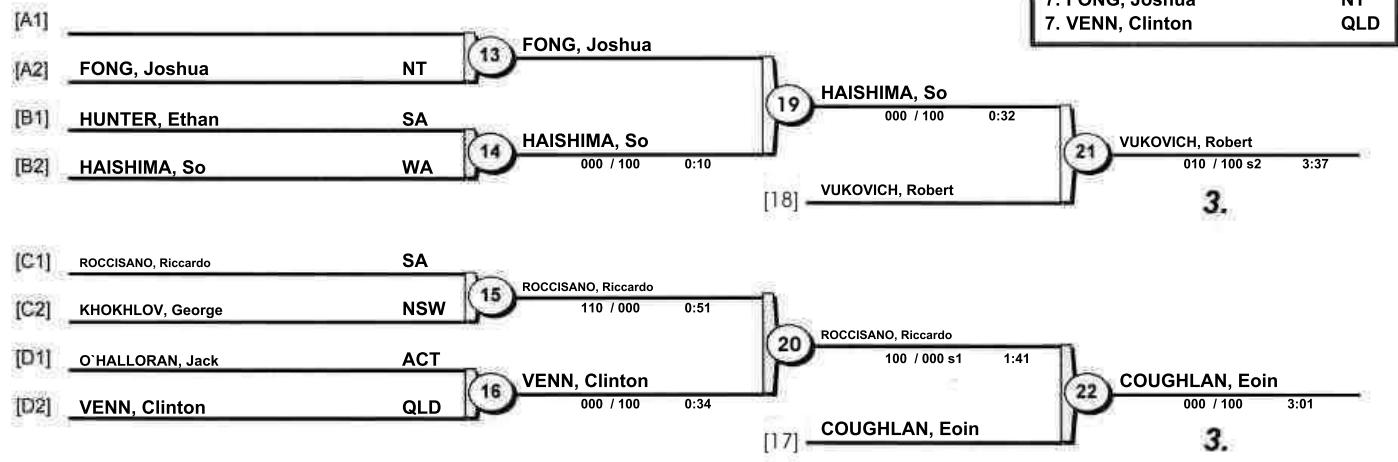

2019 Australian National Championships

Cararra (AUS), 09 Jun 2019

-100 kg

14 Judoka

POOL A

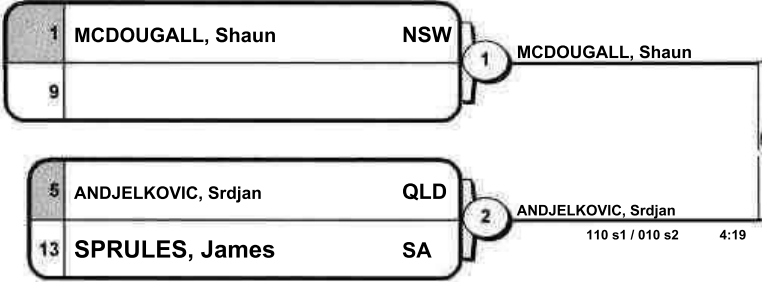

POOL B

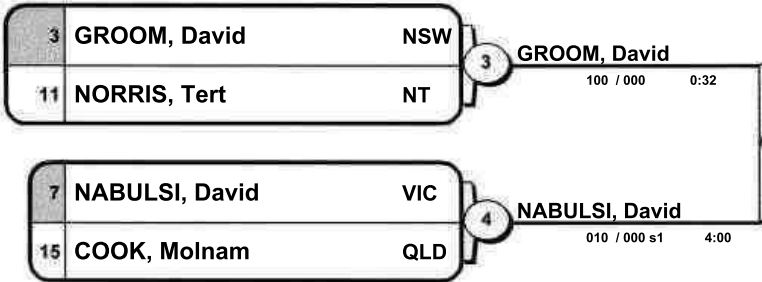

POOL C

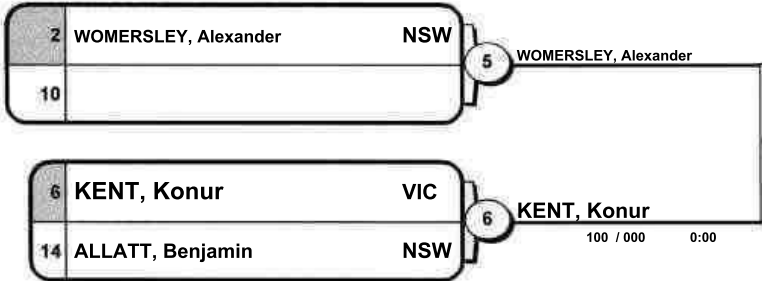

POOL D

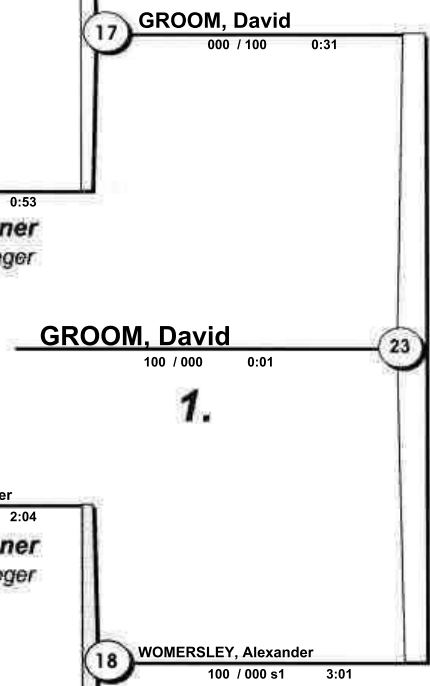
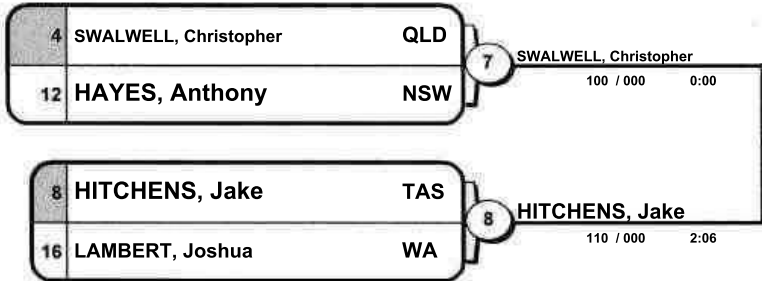

1.

Results	
Résultat / Platzierungen	
1. GROOM, David	NSW
2. WOMERSLEY, Alexander	NSW
3. SWALWELL, Christopher	QLD
3. MCDUGALL, Shaun	NSW
5. ANDJELKOVIC, Srdjan	QLD
5. HITCHENS, Jake	TAS
7. NABULSI, David	VIC
7. KENT, Konur	VIC

Repechage / Trostrunde

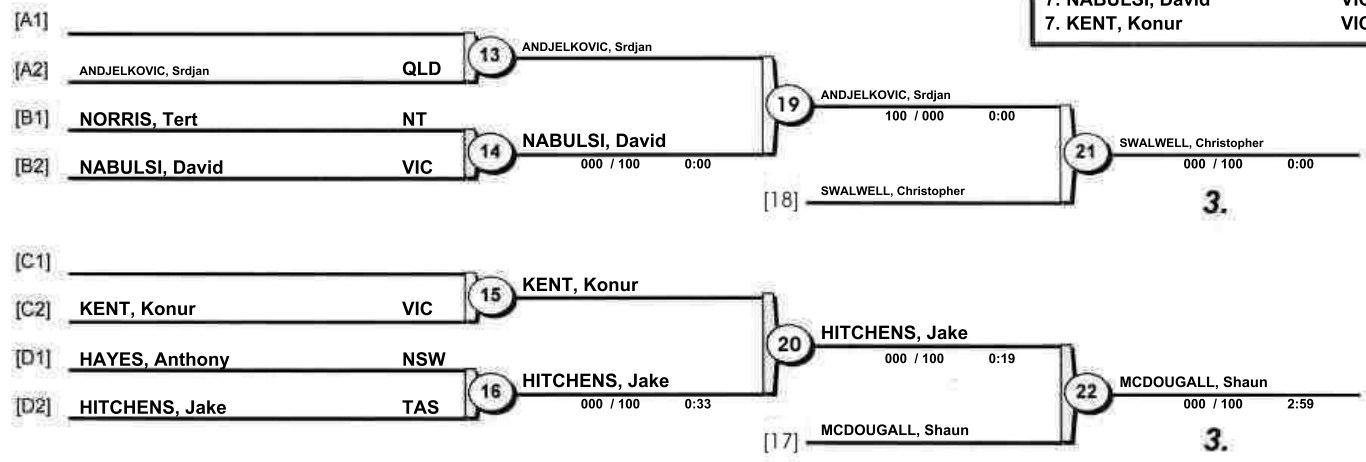

2019 Australian National Championships

Cararra (AUS), 09 Jun 2019

+100 kg

8 Judoka

POOL A

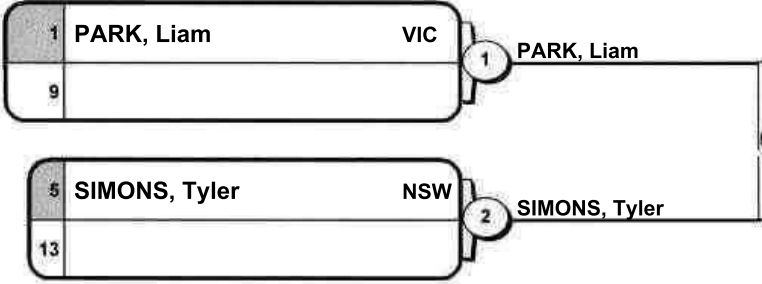

POOL B

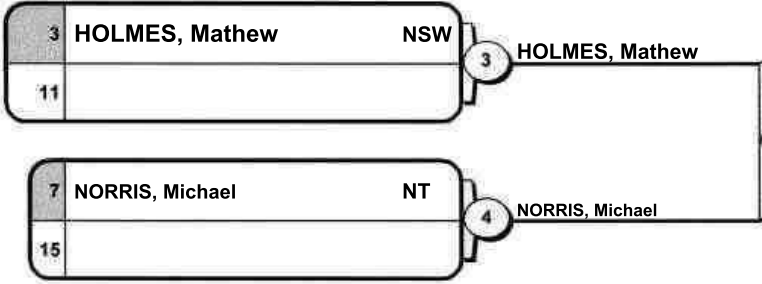

POOL C

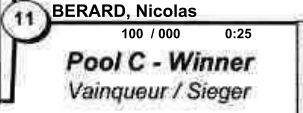
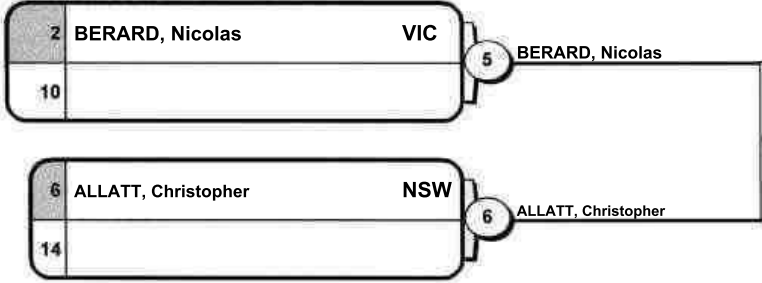

POOL D

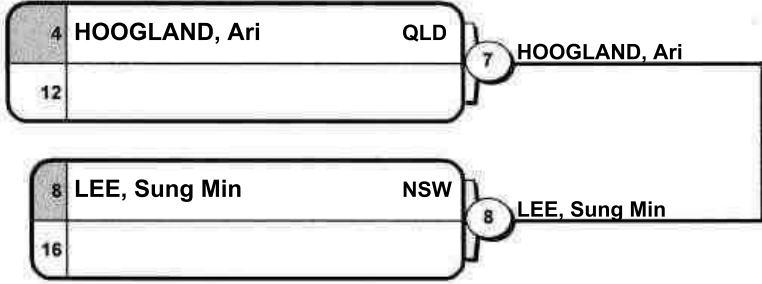

1.

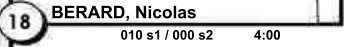

Results	
Résultat / Platzierungen	
1. BERARD, Nicolas	VIC
2. PARK, Liam	VIC
3. LEE, Sung Min	NSW
3. HOOGLAND, Ari	QLD
5. NORRIS, Michael	NT
5. HOLMES, Mathew	NSW
7. SIMONS, Tyler	NSW
7. ALLATT, Christopher	NSW

Repechage / Trostrunde

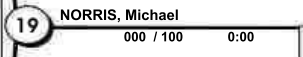
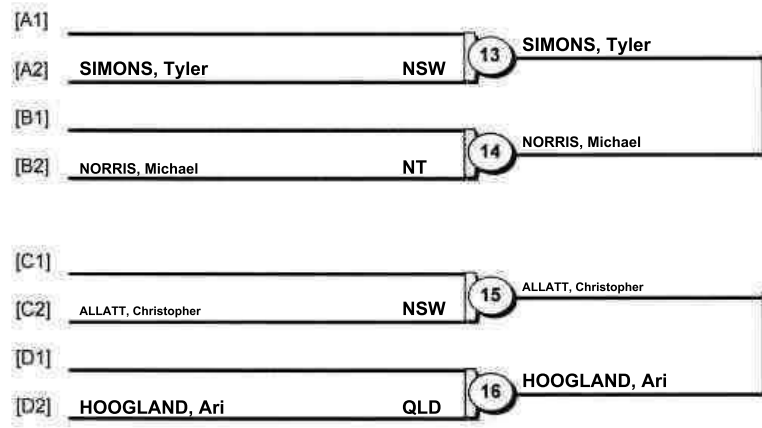

3.

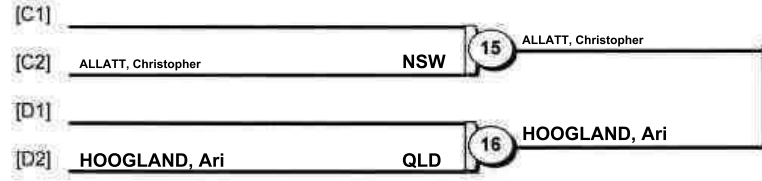

3.

2019 Australian National Championships

Cararra (AUS), 09 Jun 2019

-48 kg

5 Judoka

			1	3	5	Wins Score	
1	MURAMATSU, Kasumi	VIC		1	1	2 0	
3	DOS SANTOS, Isabel	VIC	0		0	0 0	
5	FIELDER, Anneliese	QLD	0	1		1 0	

			2	4	Wins	Scores
2	MEYER, Amy	SA		0		(0)
4	AHARONI, Aimee	VIC	1			(0)

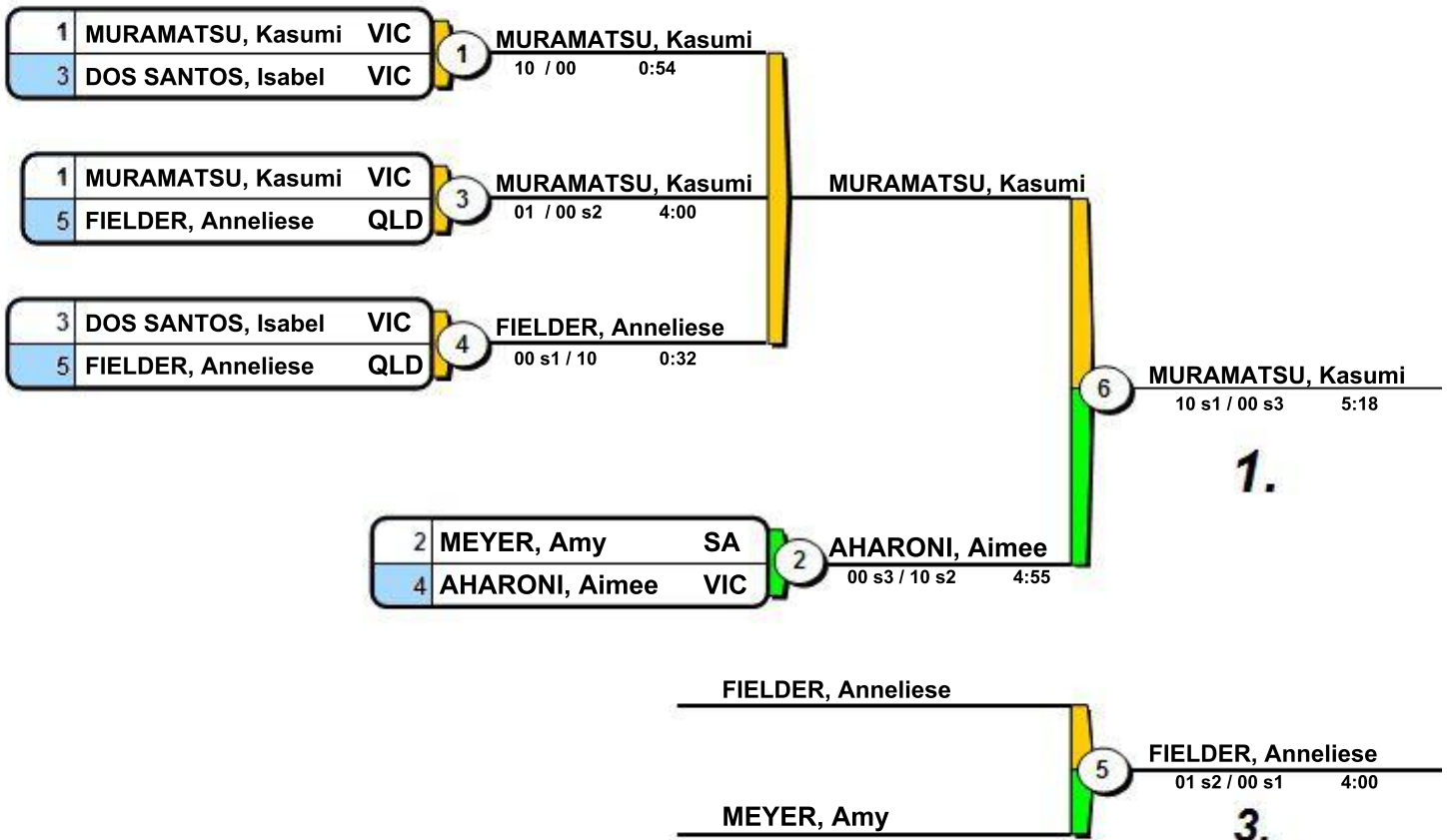

Final Results

1. MURAMATSU, Kasumi VIC
2. AHARONI, Aimee VIC
3. FIELDER, Anneliese QLD

2019 Australian National Championships

Cararra (AUS), 09 Jun 2019

-52 kg

2 Judoka

BEST OF THREE

1	CHALMERS, Kim	VIC	1	NODA, Ririko	NSW	00 s1 / 10 s1	2:43
2	NODA, Ririko	NSW					

1	CHALMERS, Kim	VIC	2	NODA, Ririko	NSW	01 / 10	1:22
2	NODA, Ririko	NSW					

1	CHALMERS, Kim	VIC	3	NODA, Ririko	NSW	00 / 10	4:00
2	NODA, Ririko	NSW					

Final Results

1. NODA, Ririko NSW
2. CHALMERS, Kim VIC

2019 Australian National Championships

Cararra (AUS), 09 Jun 2019

-57 kg

8 Judoka

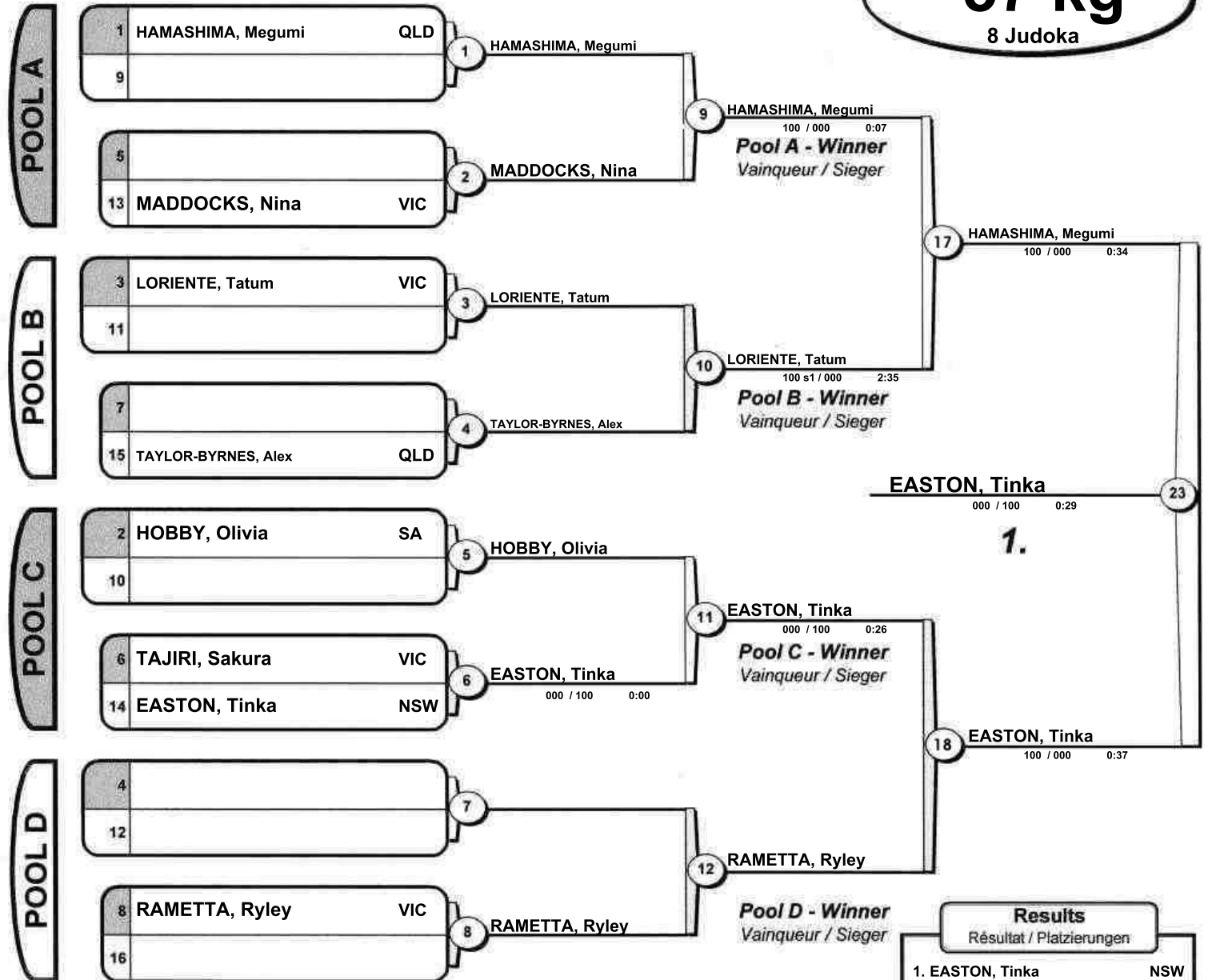

Results	
Résultat / Platzierungen	
1. EASTON, Tinka	NSW
2. HAMASHIMA, Megumi	QLD
3. MADDOCKS, Nina	VIC
3. LORIENTE, Tatum	VIC
5. RAMETTA, Ryley	VIC
5. HOBBY, Olivia	SA
7. TAYLOR-BYRNES, Alex	QLD
7.	

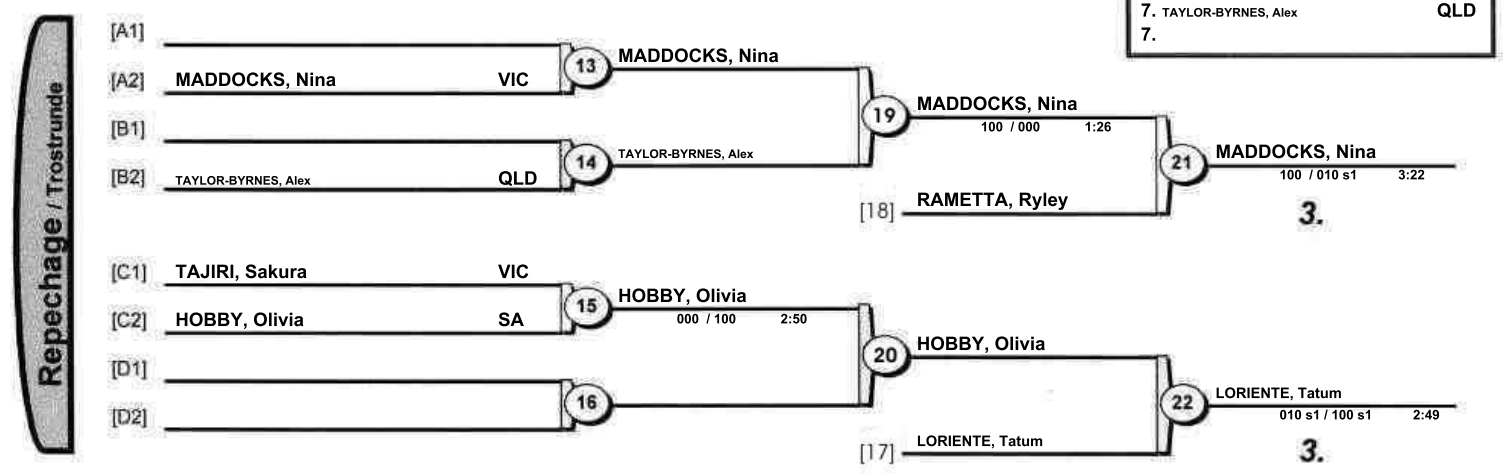

2019 Australian National Championships

Cararra (AUS), 09 Jun 2019

-63 kg

10 Judoka

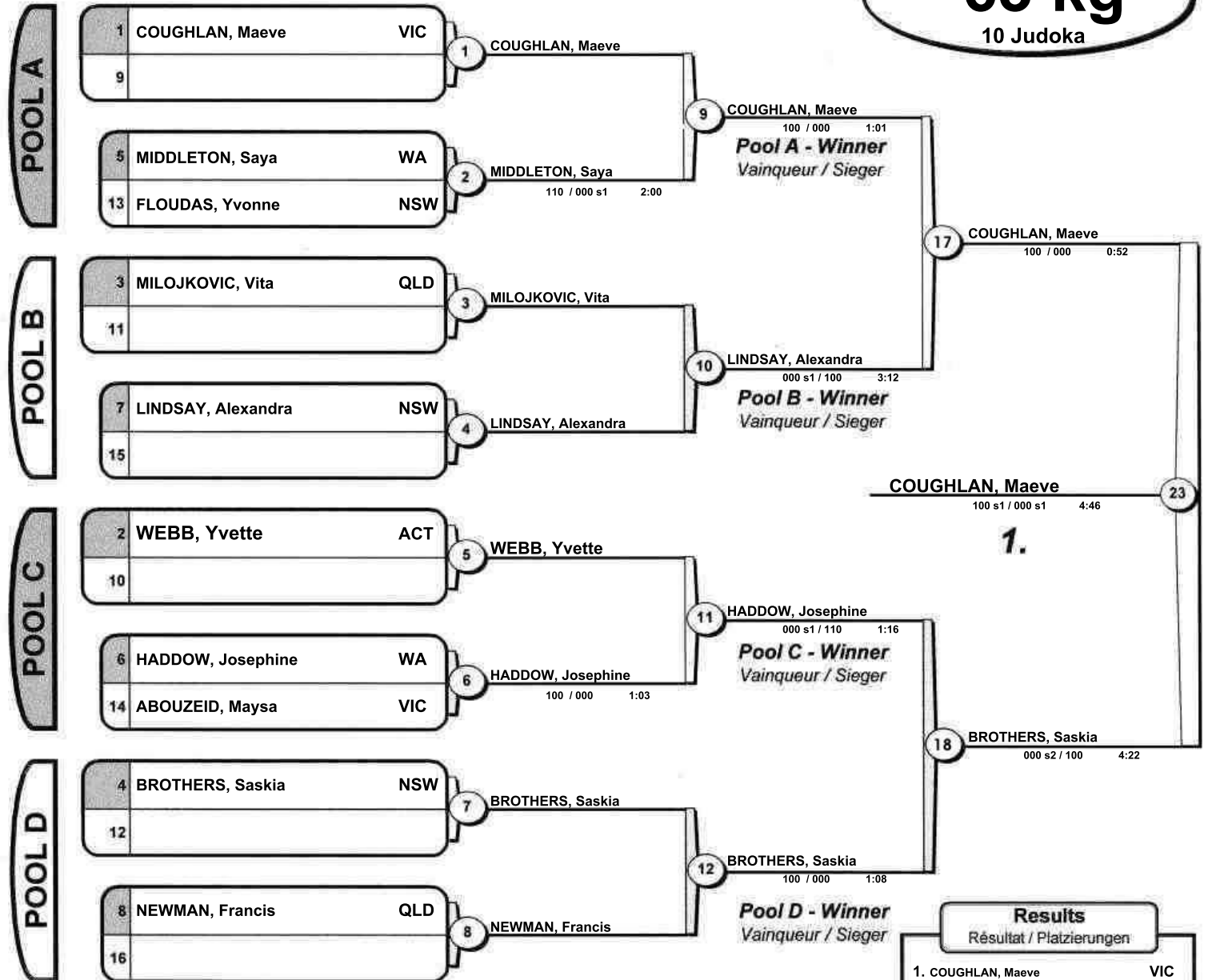

Results	
Résultat / Platzierungen	
1. COUGHLAN, Maeve	VIC
2. BROTHERS, Saskia	NSW
3. MIDDLETON, Saya	WA
3. LINDSAY, Alexandra	NSW
5. HADDOW, Josephine	WA
5. NEWMAN, Francis	QLD
7. MILOJKOVIC, Vita	QLD
7. WEBB, Yvette	ACT

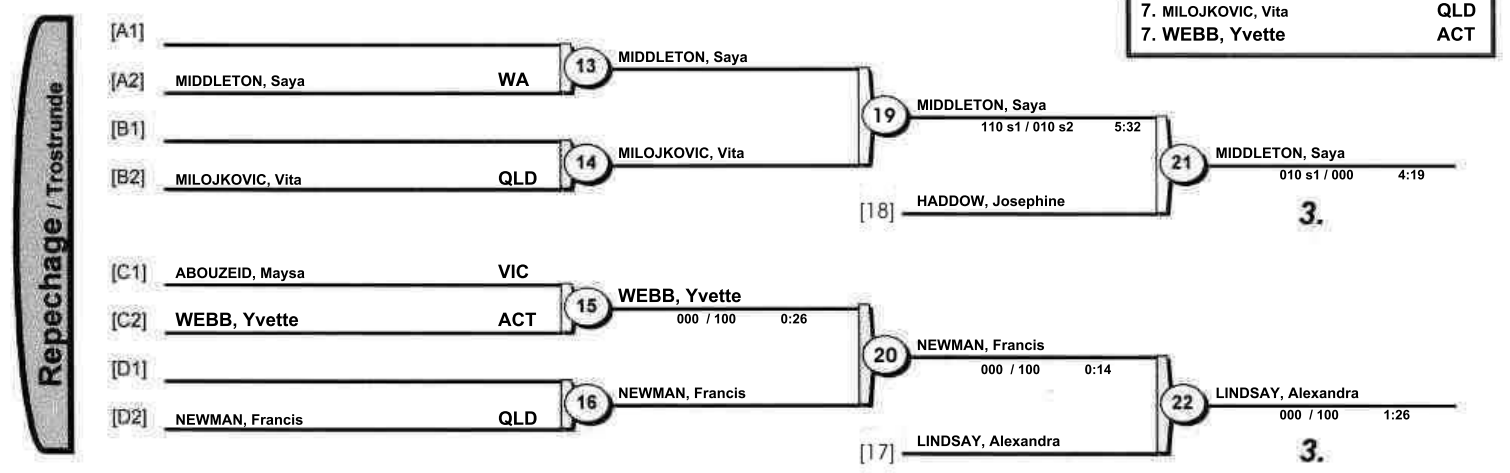

2019 Australian National Championships

Cararra (AUS), 09 Jun 2019

-70 kg

5 Judoka

			1	3	5	Wins Score	
1	ARLOVE, Cathy	VIC		0	0	0 0	
3	SWAN, Maria	WA	1		0	1 0	
5	HAECKER, Katharina	QLD	1	1		2 0	

			2	4	Wins	Scores
2	COUGHLAN, Aoife	VIC		1		(0)
4	STRONG, Erin	NT	0			(0)

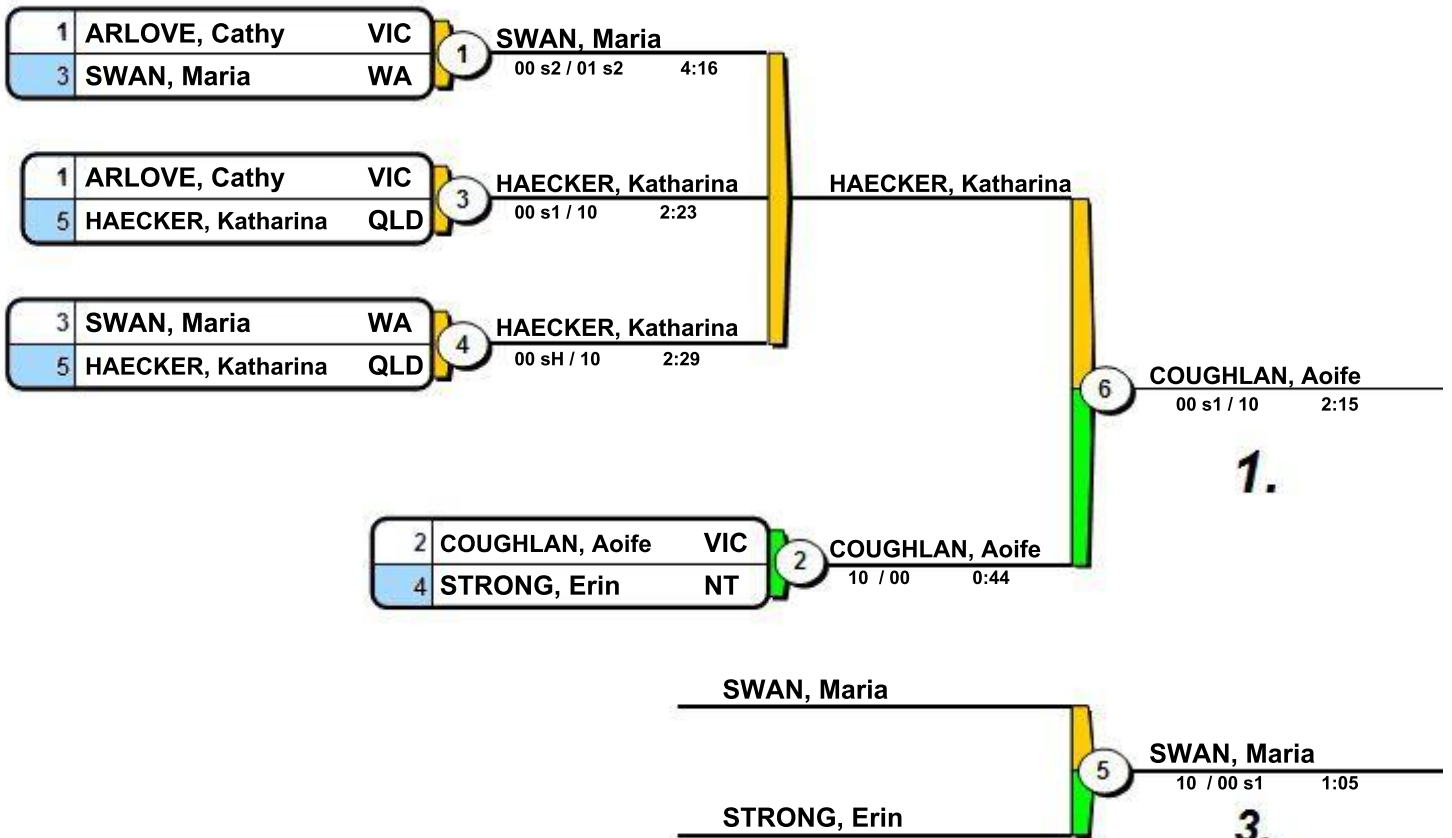

Final Results

1. COUGHLAN, Aoife VIC
2. HAECKER, Katharina QLD
3. SWAN, Maria WA

2019 Australian National Championships

Cararra (AUS), 09 Jun 2019

-78 kg

5 Judoka

	1	3	5	Wins Score	
1 PADUCH, Abigail NSW		1	0	1 0	
3 JOHANSSON-CRANFIELD, Kiana ACT	0		0	0 0	
5 USENKO, Olena QLD	1	1		2 0	

	2	4	Wins	Scores
2 WALLIS, Melanie VIC		0		(0)
4 COLLINS, Sara VIC	1			(0)

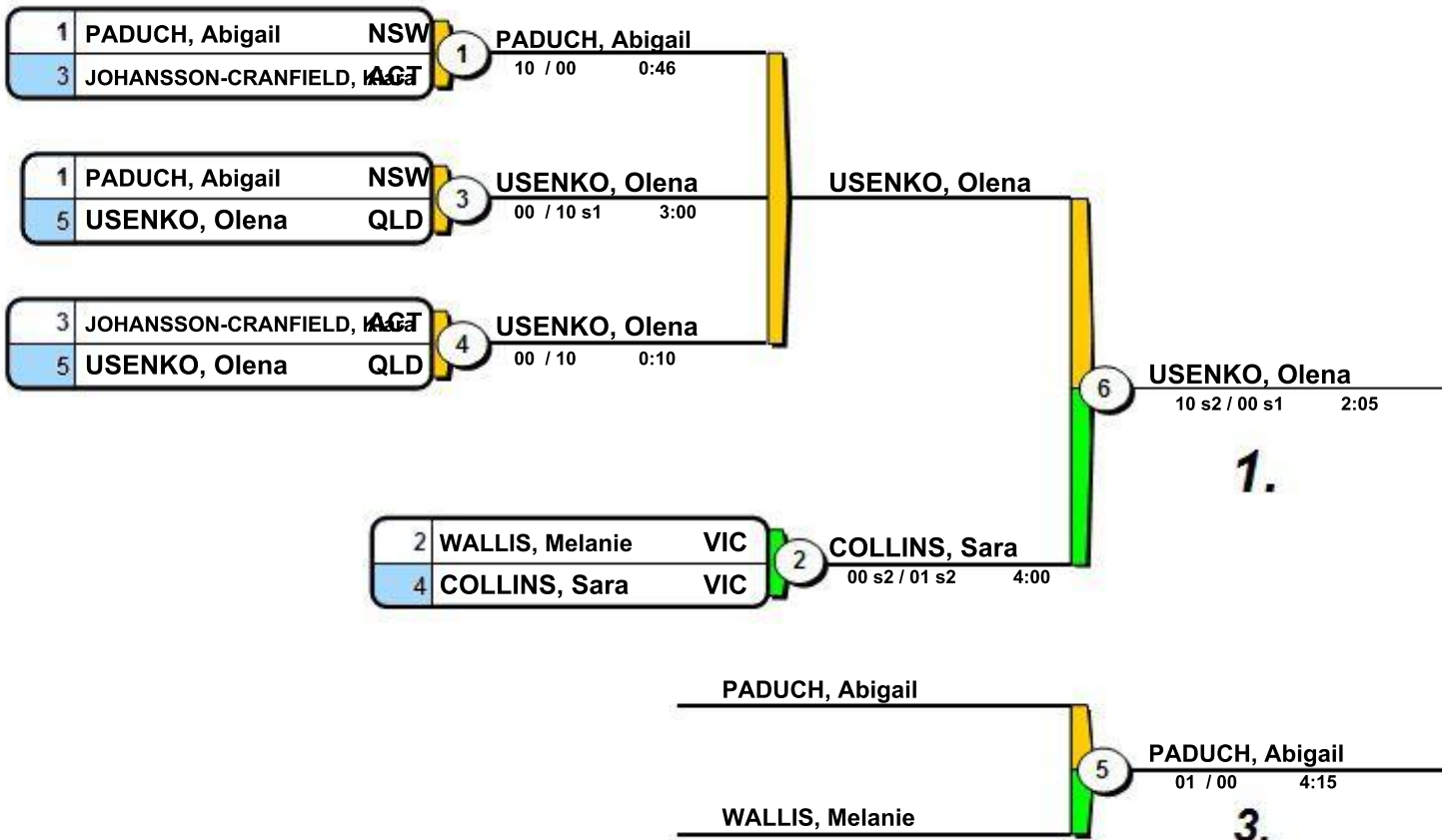

Final Results

1. USENKO, Olena QLD
2. COLLINS, Sara VIC
3. PADUCH, Abigail NSW

2019 Australian National Championships

Carrara (AUS), 09 Jun 2019

-60 kg

7 Judoka

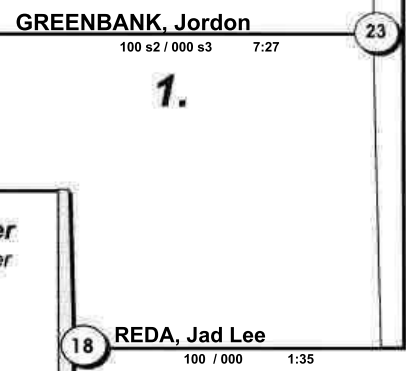
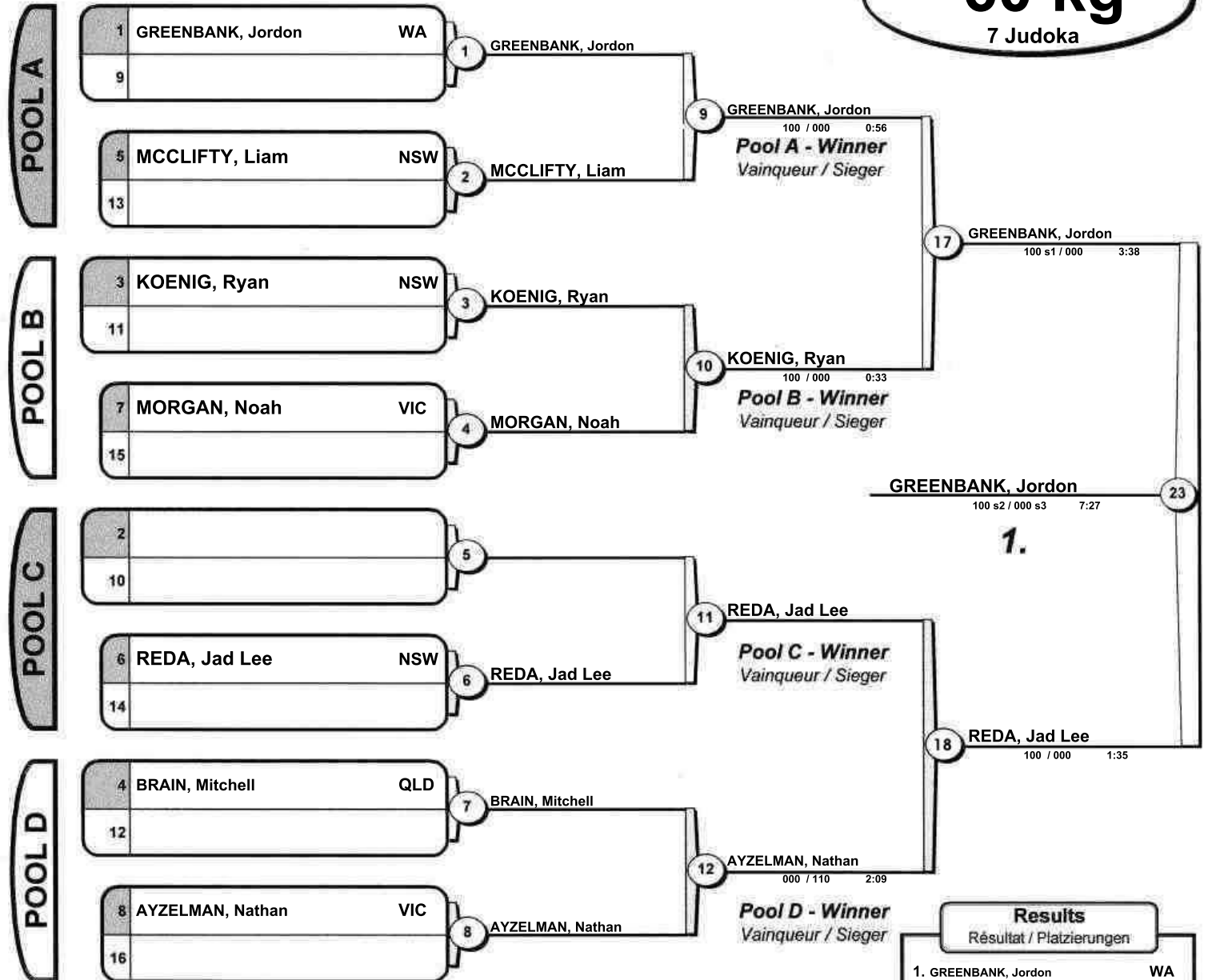

Results	
Résultat / Platzierungen	
1. GREENBANK, Jordon	WA
2. REDA, Jad Lee	NSW
3. AYZELMAN, Nathan	VIC
3. KOENIG, Ryan	NSW
5. MCCLIFTY, Liam	NSW
6. BRAIN, Mitchell	QLD
7. MORGAN, Noah	VIC
7.	

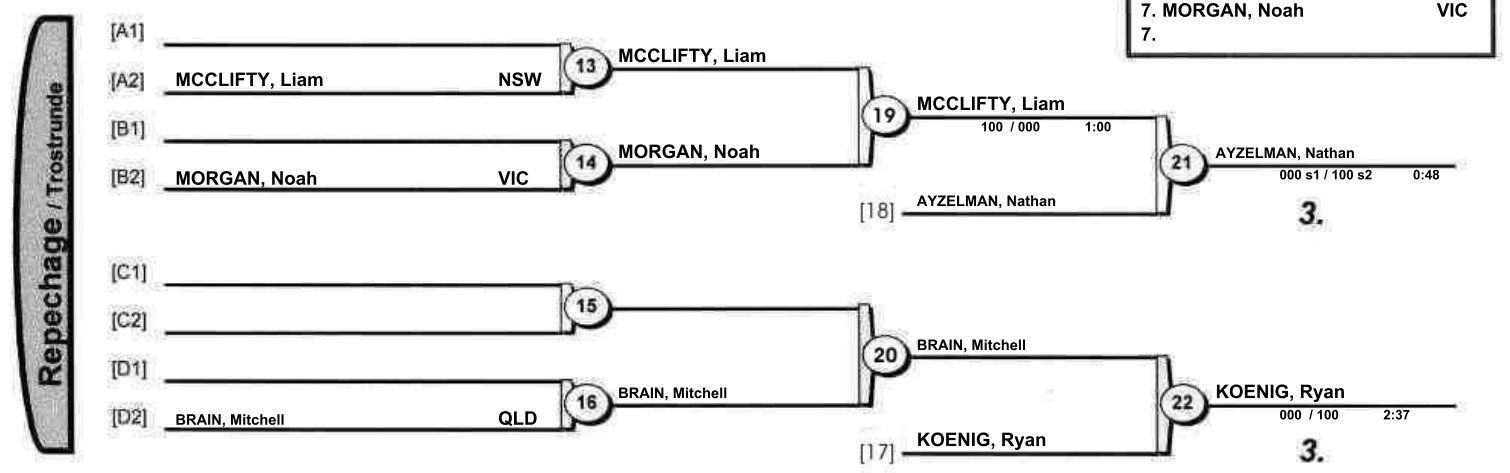

2019 Australian National Championships

Carrara (AUS), 09 Jun 2019

-66 kg

11 Judoka

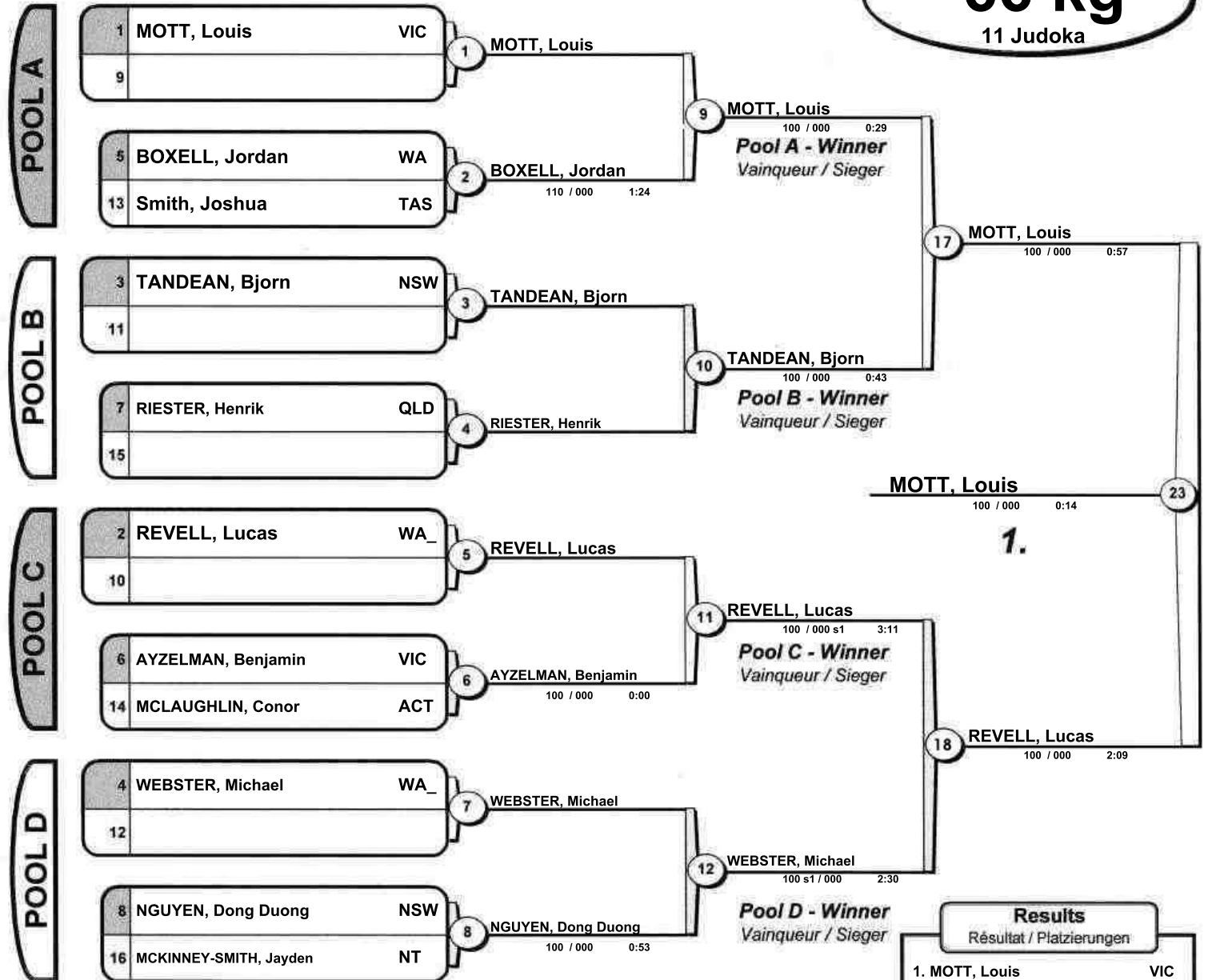

Results	
Résultat / Platzierungen	
1.	MOTT, Louis VIC
2.	REVELL, Lucas WA
3.	WEBSTER, Michael WA
3.	AYZELMAN, Benjamin VIC
5.	BOXELL, Jordan WA
5.	TANDEAN, Bjorn NSW
7.	RIESTER, Henrik QLD
7.	NGUYEN, Dong Duong NSW

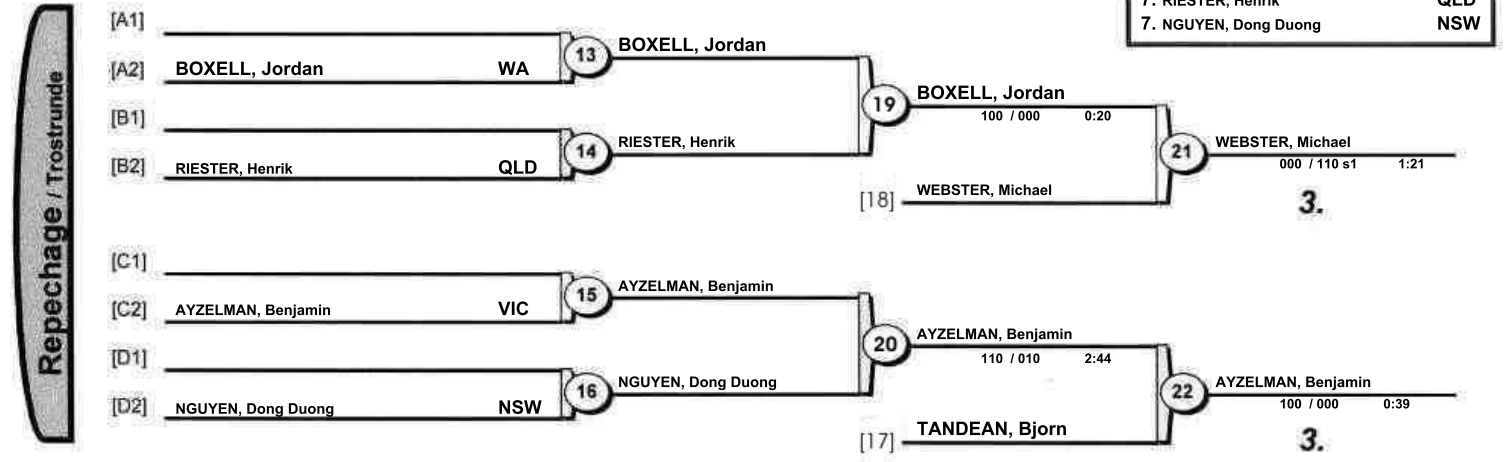

2019 Australian National Championships

Carrara (AUS), 09 Jun 2019

-73 kg

15 Judoka

POOL A

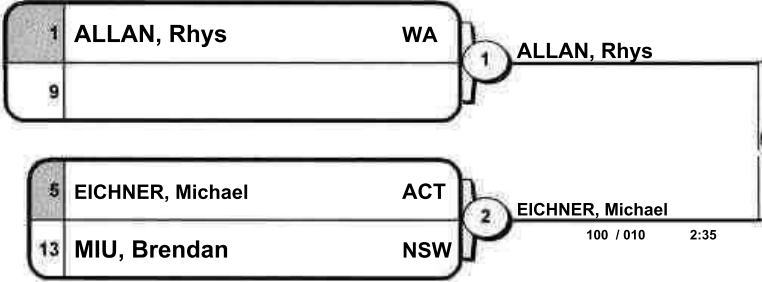

POOL B

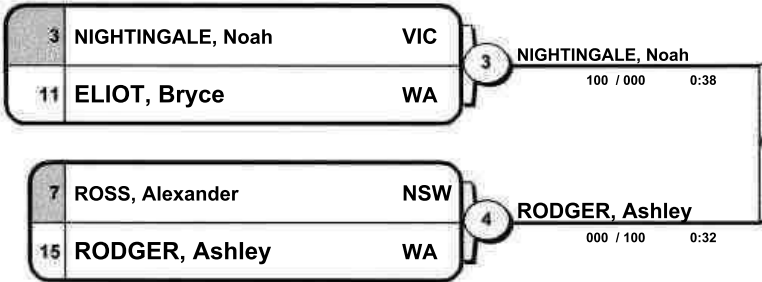

POOL C

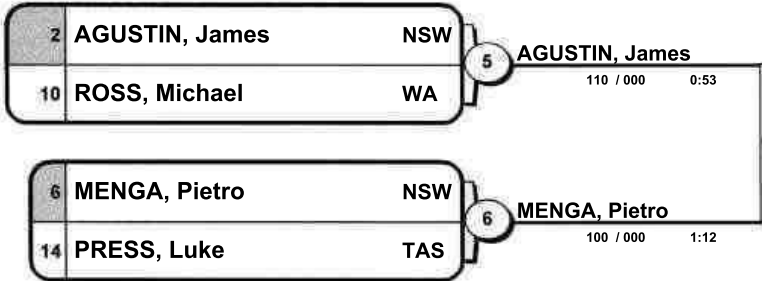

POOL D

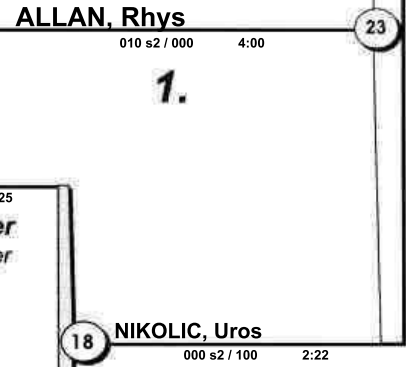
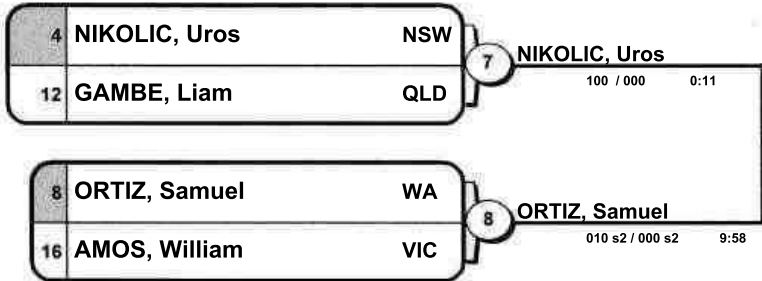

Results		
Résultat / Platzierungen		
1.	ALLAN, Rhys	WA
2.	NIKOLIC, Uros	NSW
3.	EICHNER, Michael	ACT
3.	NIGHTINGALE, Noah	VIC
5.	AGUSTIN, James	NSW
5.	GAMBE, Liam	QLD
7.	RODGER, Ashley	WA
7.	MENGA, Pietro	NSW

Repechage / Trostrunde

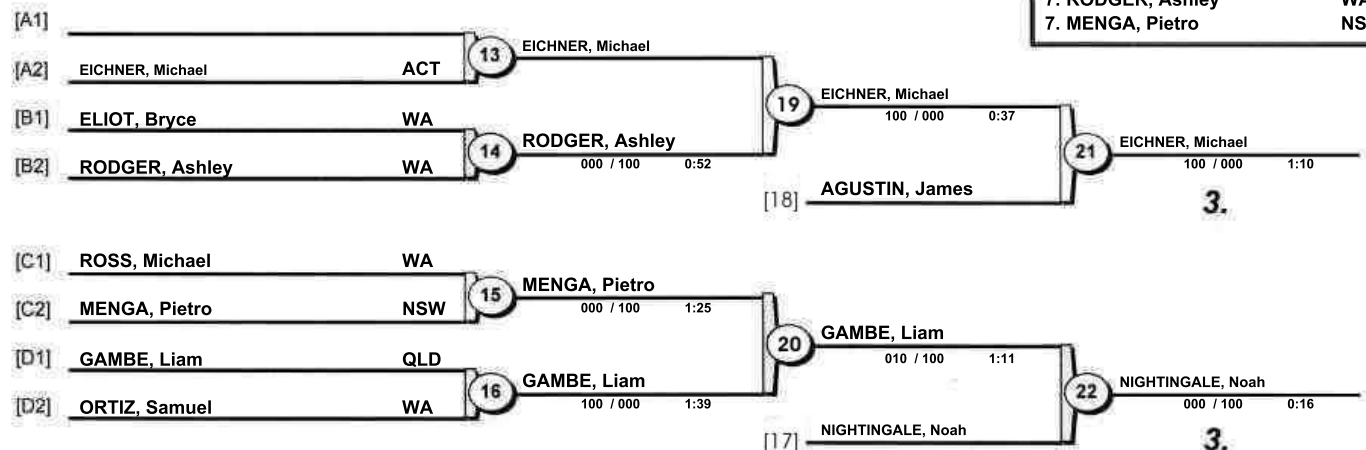

2019 Australian National Championships

Carrara (AUS), 09 Jun 2019

-81 kg

9 Judoka

POOL A

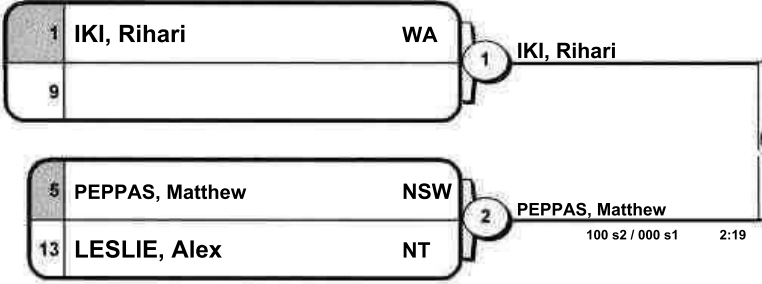

POOL B

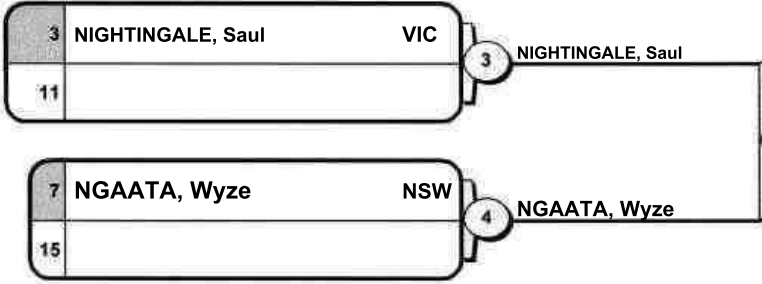

POOL C

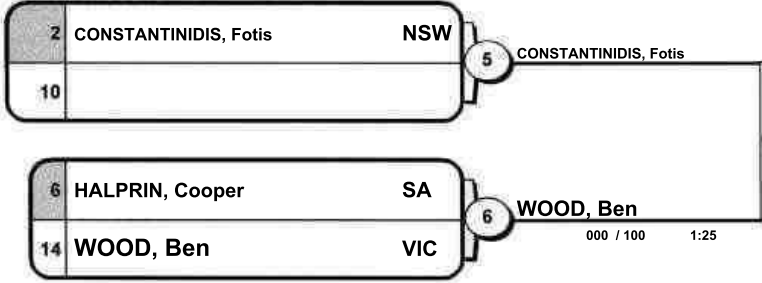

POOL D

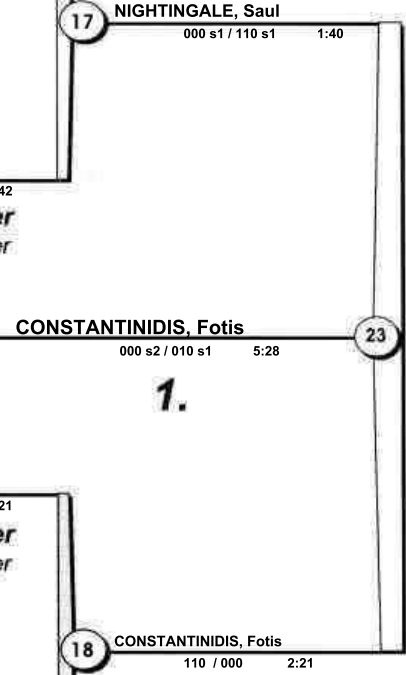
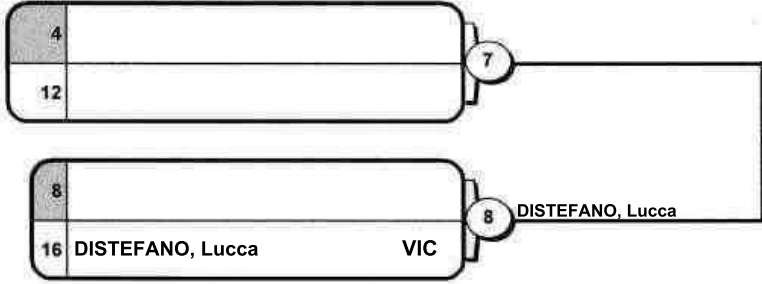

Results	
Résultat / Platzierungen	
1.	CONSTANTINIDIS, Fotis NSW
2.	NIGHTINGALE, Saul VIC
3.	DISTEFANO, Lucca VIC
3.	IKI, Rihari WA
5.	PEPPAS, Matthew NSW
5.	WOOD, Ben VIC
7.	NGAATA, Wyze NSW
7.	

Repechage / Trostrunde

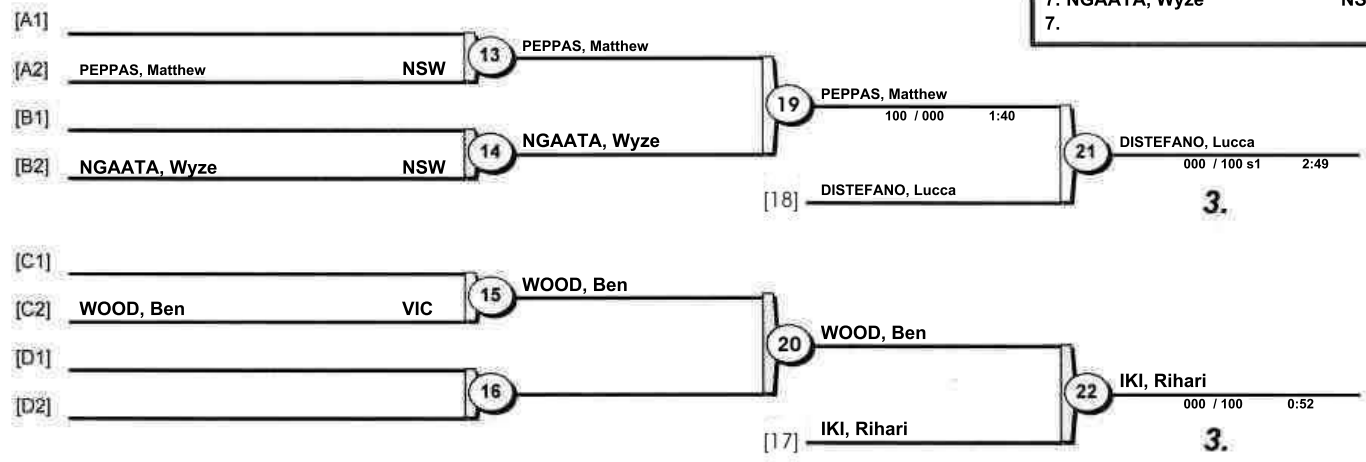

2019 Australian National Championships

Carrara (AUS), 09 Jun 2019

-90 kg

6 Judoka

POOL A

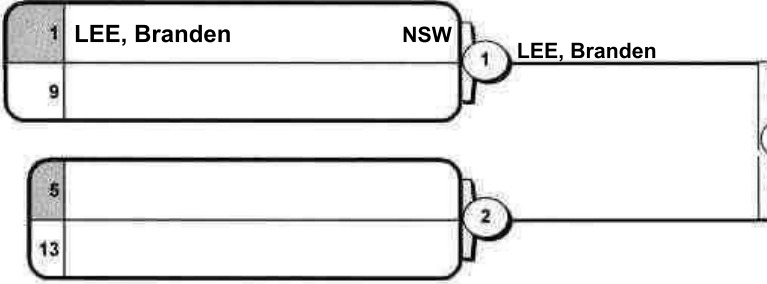

Pool A - Winner
Vainqueur / Sieger

POOL B

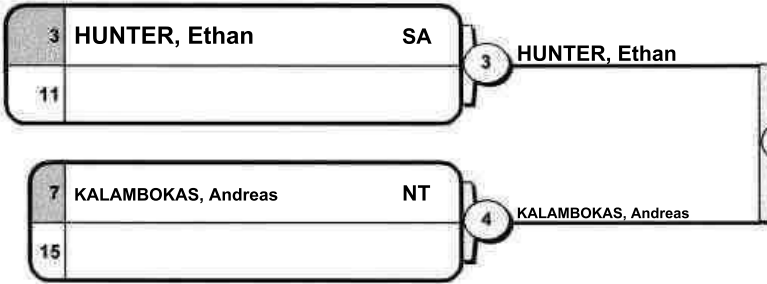

Pool B - Winner
Vainqueur / Sieger

POOL C

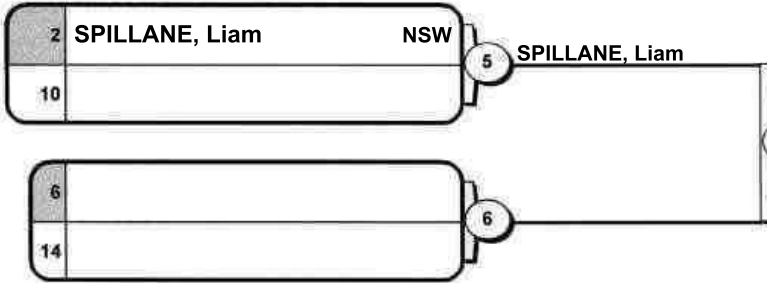

Pool C - Winner
Vainqueur / Sieger

POOL D

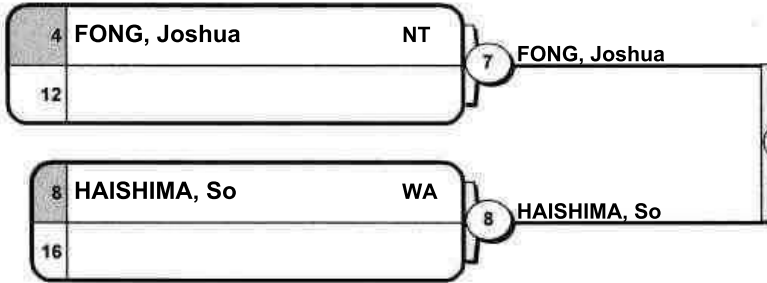

Pool D - Winner
Vainqueur / Sieger

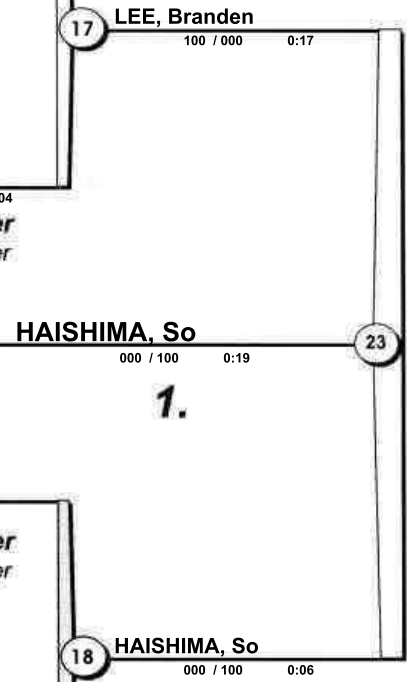

HAISHIMA, So
000 / 100 0:19

1.

Results	
Résultat / Platzierungen	
1. HAISHIMA, So	WA
2. LEE, Branden	NSW
3. SPILLANE, Liam	NSW
3. FONG, Joshua	NT
5. HUNTER, Ethan	SA
5. KALAMBOKAS, Andreas	NT
7.	
7.	

Repechage / Trostrunde

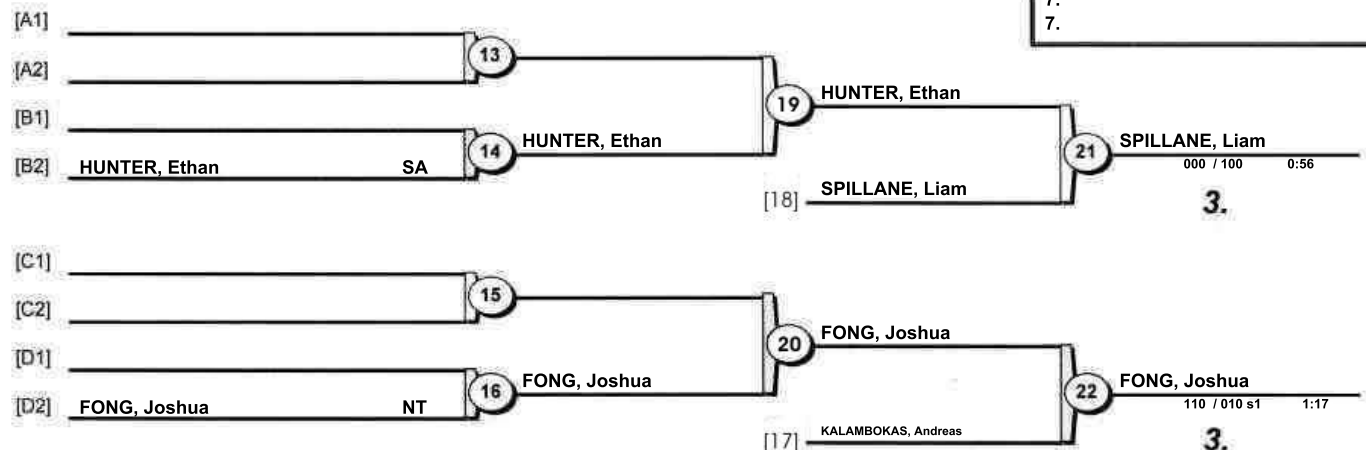

2019 Australian National Championships

Carrara (AUS), 09 Jun 2019

+100 kg

3 Judoka

			1	2	3	Wins Score	
1	LEE, Sung Min	NSW		1	1	2 0	
2	ALLATT, Christopher	NSW	0		1	1 0	
3	ALLATT, Benjamin	NSW	0	0		0 0	

1	LEE, Sung Min	NSW	1	LEE, Sung Min		NSW
2	ALLATT, Christopher	NSW		11 / 00	0:48	

1	LEE, Sung Min	NSW	2	LEE, Sung Min		NSW
3	ALLATT, Benjamin	NSW		10 / 00	0:00	

2	ALLATT, Christopher	NSW	3	ALLATT, Christopher		NSW
3	ALLATT, Benjamin	NSW		10 / 00	0:00	

Final Results

1. LEE, Sung Min NSW
2. ALLATT, Christopher NSW
- 3.

2019 Australian National Championships

Carrara (AUS), 09 Jun 2019

-48 kg

6 Judoka

POOL A

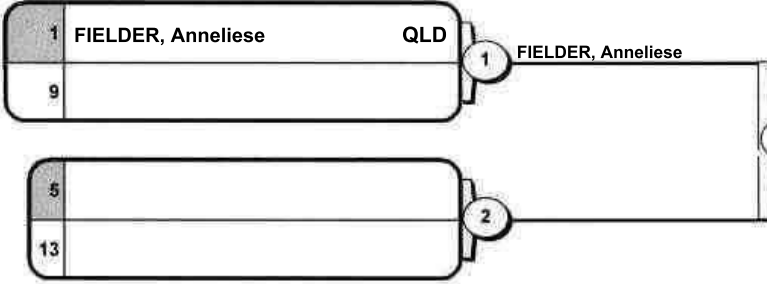

POOL B

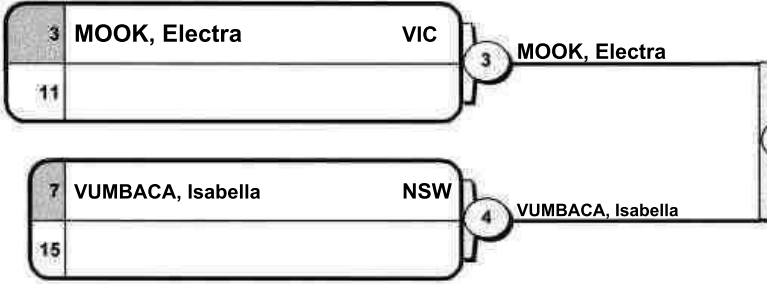

POOL C

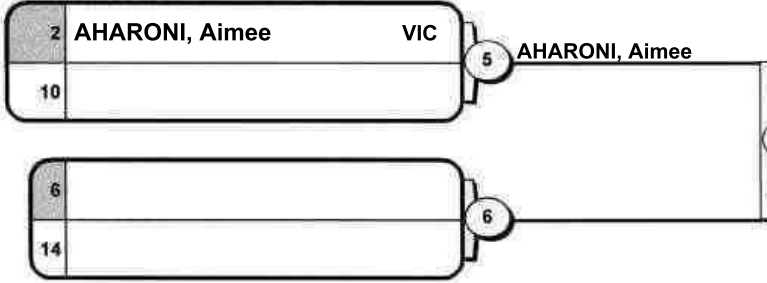

POOL D

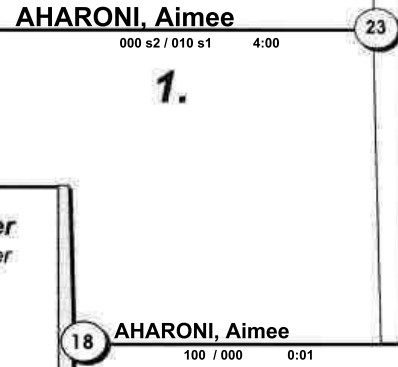
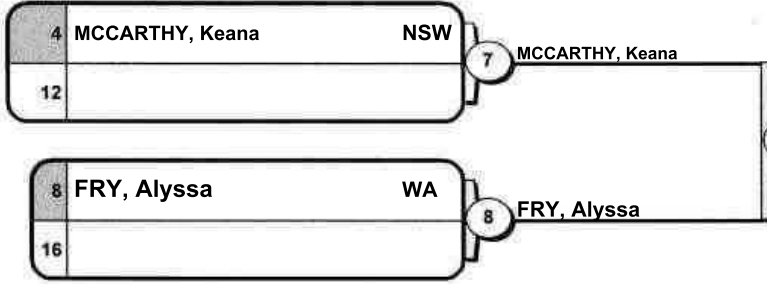

Results	
Résultat / Platzierungen	
1. AHARONI, Aimee	VIC
2. FIELDER, Anneliese	QLD
3. MCCARTHY, Keana	NSW
3. FRY, Alyssa	WA
5. MOOK, Electra	VIC
5. VUMBACA, Isabella	NSW
7.	
7.	

Repechage / Trostrunde

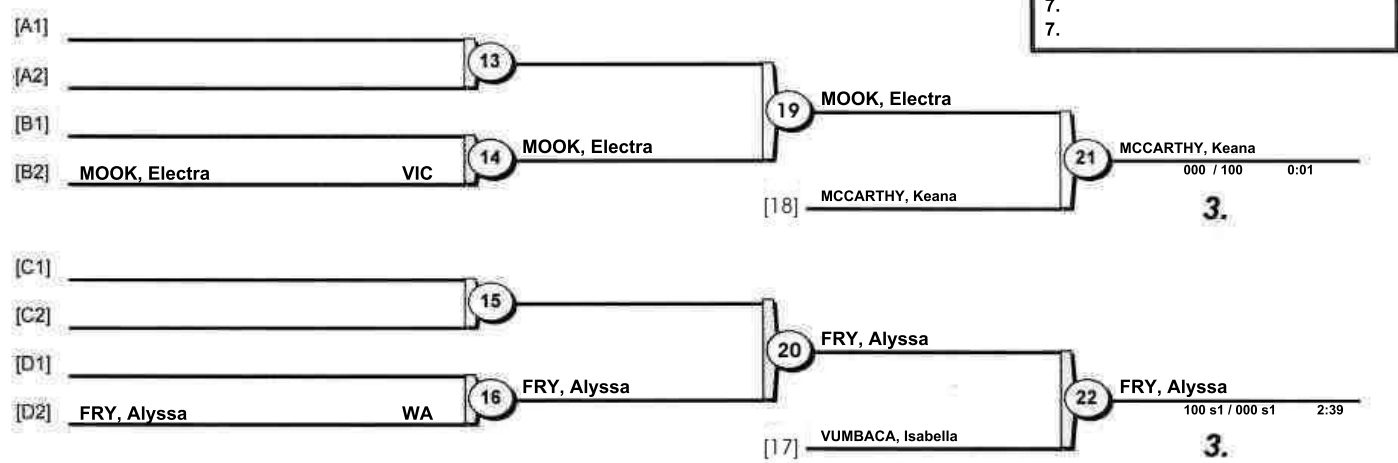

2019 Australian National Championships

Carrara (AUS), 09 Jun 2019

-52 kg

5 Judoka

	1	3	5	Wins	Score
1 MCCRACKEN, Nytalie WA		0	0	0	0
3 VUMBACA, Jacinta NSW	1		0	1	0
5 CRAMP, Bethany ACT	1	1		2	0

	2	4	Wins	Scores
2 TAYLOR, Charisma QLD		1		(0)
4 BOYD, Katelyn NSW	0			(0)

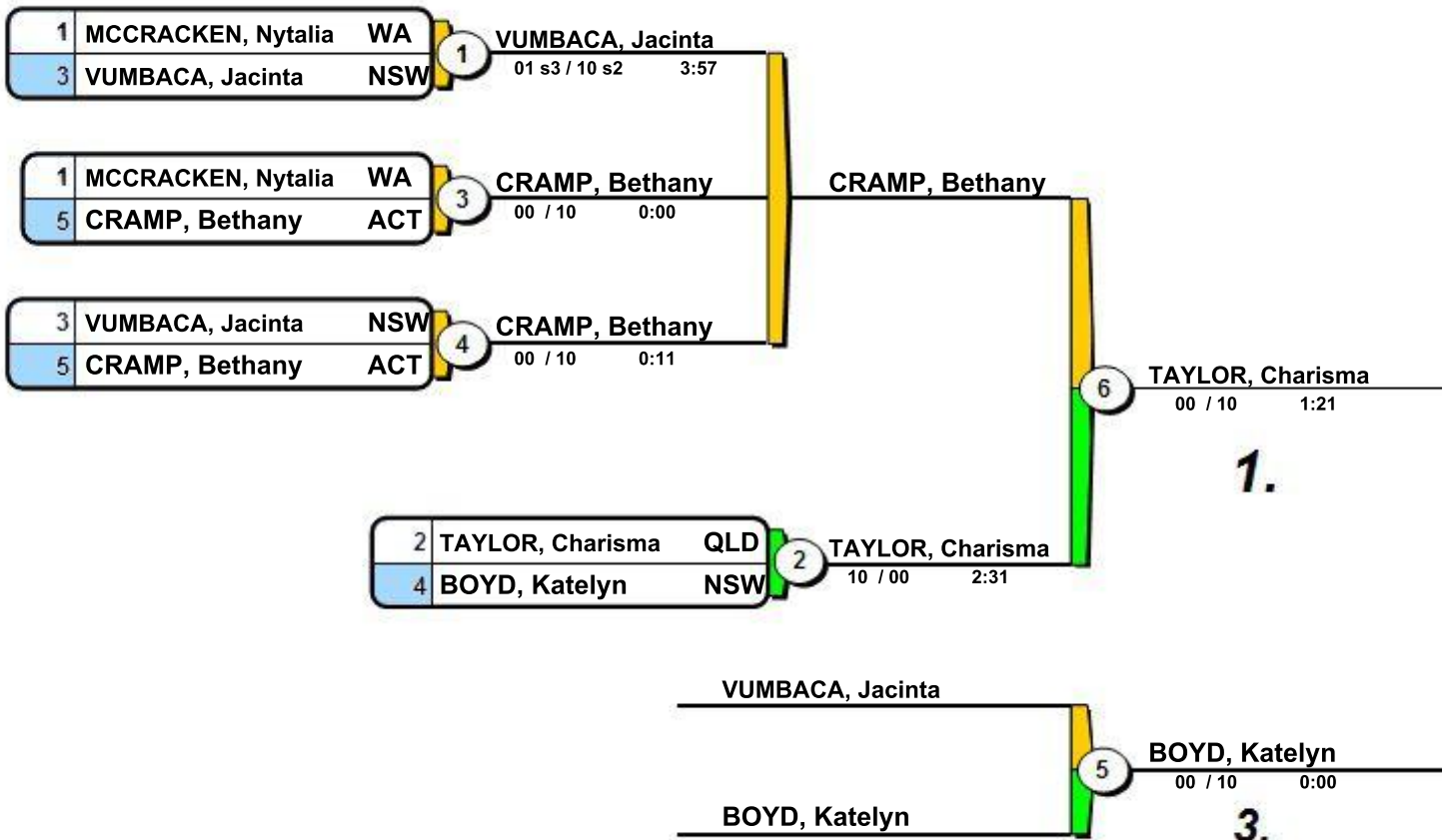

Final Results

1. TAYLOR, Charisma QLD
2. CRAMP, Bethany ACT
3. BOYD, Katelyn NSW

2019 Australian National Championships

Carrara (AUS), 09 Jun 2019

-57 kg

7 Judoka

POOL A

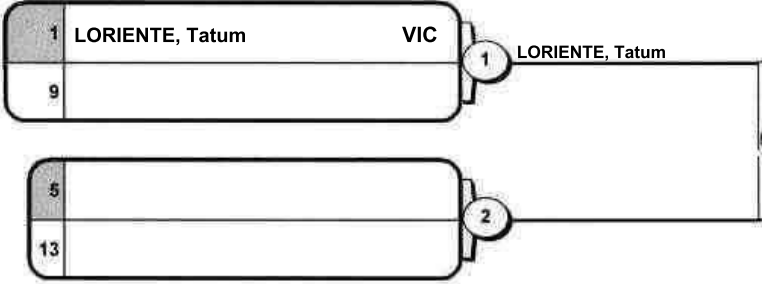

POOL B

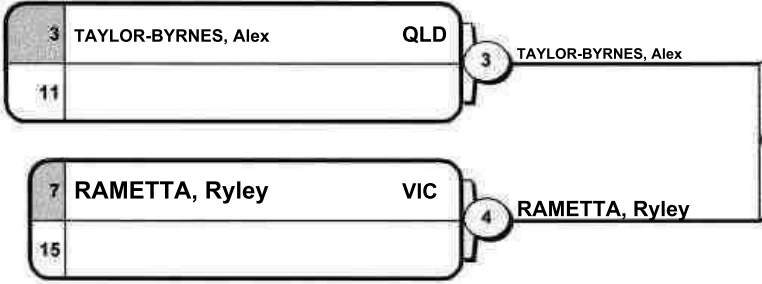

POOL C

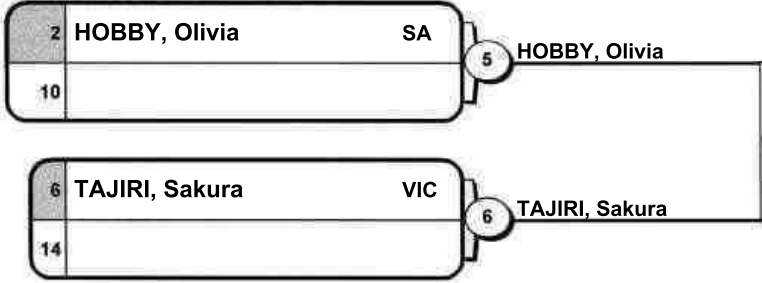

POOL D

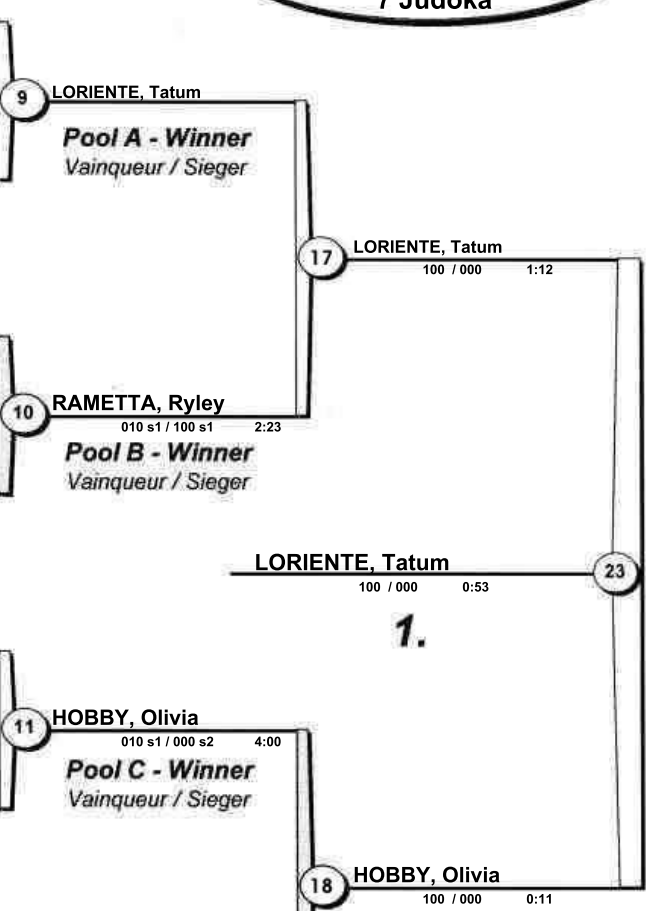
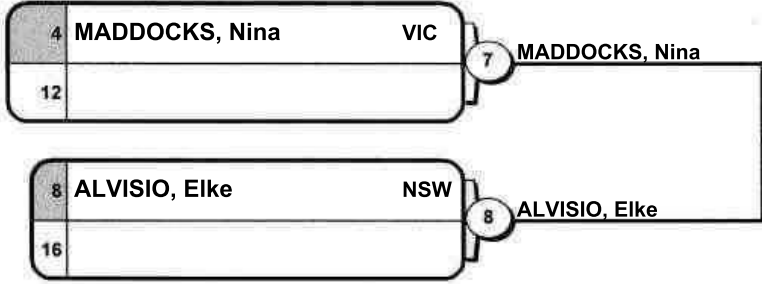

Results	
Résultat / Platzierungen	
1.	LORIENTE, Tatum VIC
2.	HOBBY, Olivia SA
3.	ALVISIO, Elke NSW
3.	RAMETTA, Ryley VIC
5.	TAYLOR-BYRNES, Alex QLD
5.	TAJIRI, Sakura VIC
7.	MADDOCKS, Nina VIC

Repechage / Trostrunde

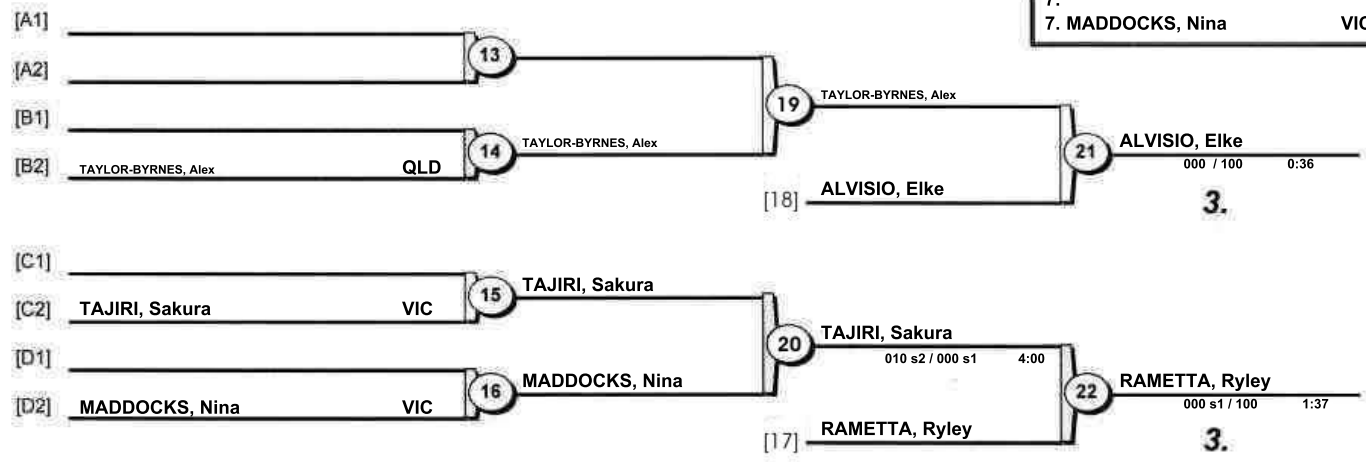

2019 Australian National Championships

Carrara (AUS), 09 Jun 2019

-63 kg

7 Judoka

POOL A

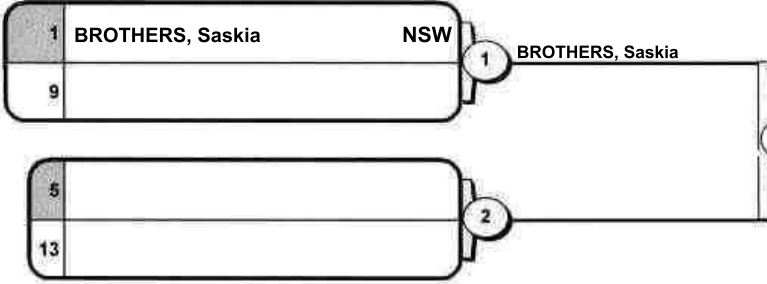

POOL B

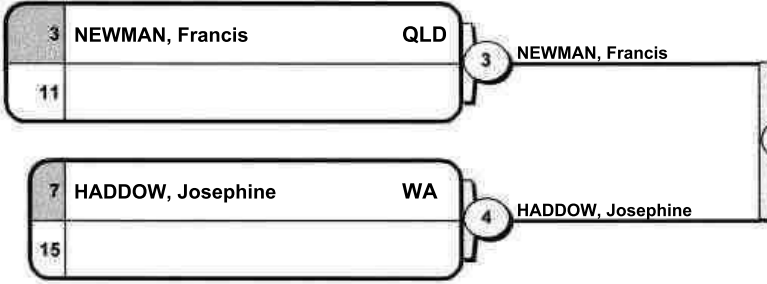

POOL C

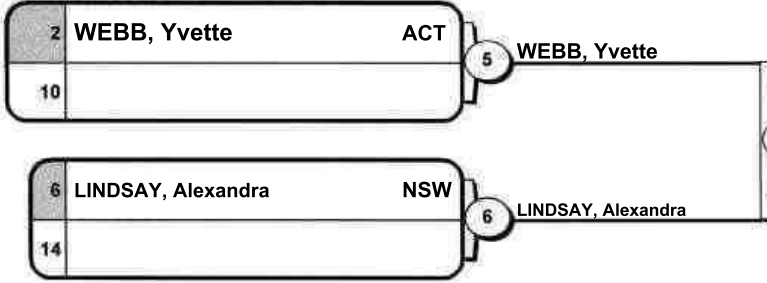

POOL D

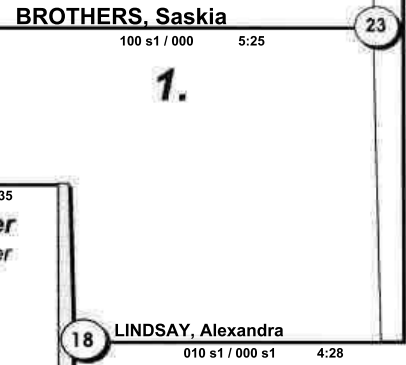
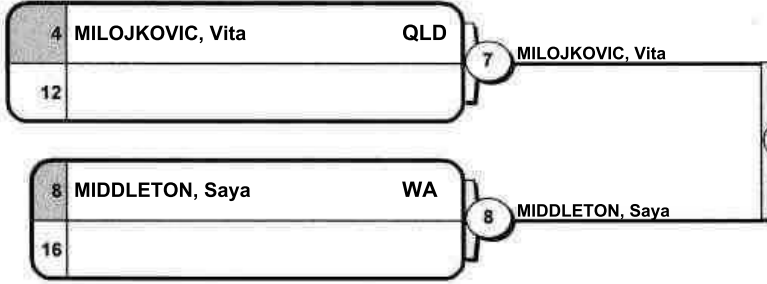

Results	
Résultat / Platzierungen	
1.	BROTHERS, Saskia NSW
2.	LINDSAY, Alexandra NSW
3.	MIDDLETON, Saya WA
3.	HADDOW, Josephine WA
5.	NEWMAN, Francis QLD
5.	MILOJKOVIC, Vita QLD
7.	WEBB, Yvette ACT

Repechage / Trostrunde

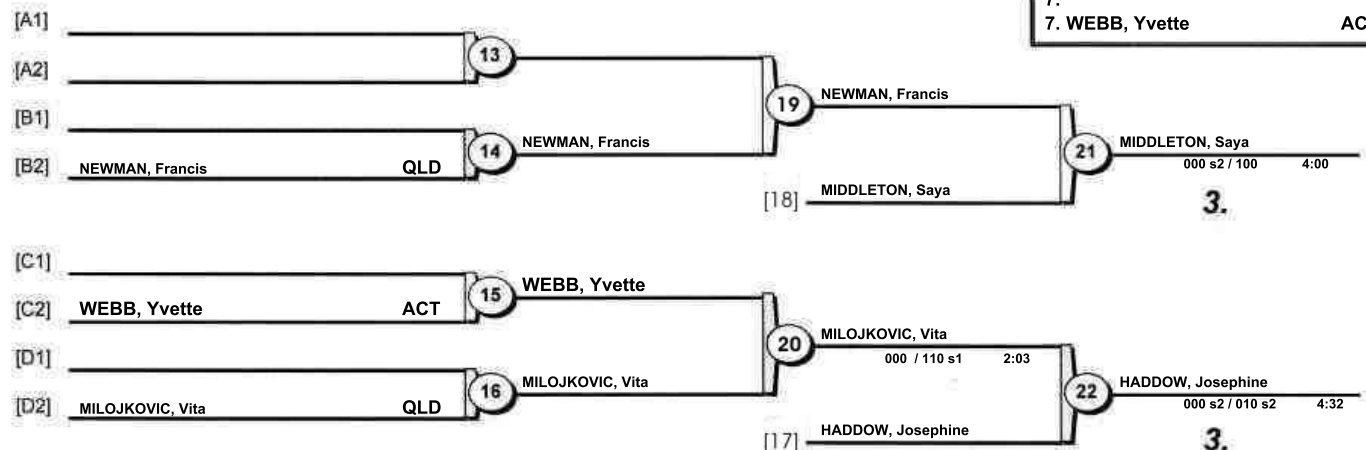

2019 Australian National Championships

Carrara (AUS), 09 Jun 2019

-70 kg

4 Judoka

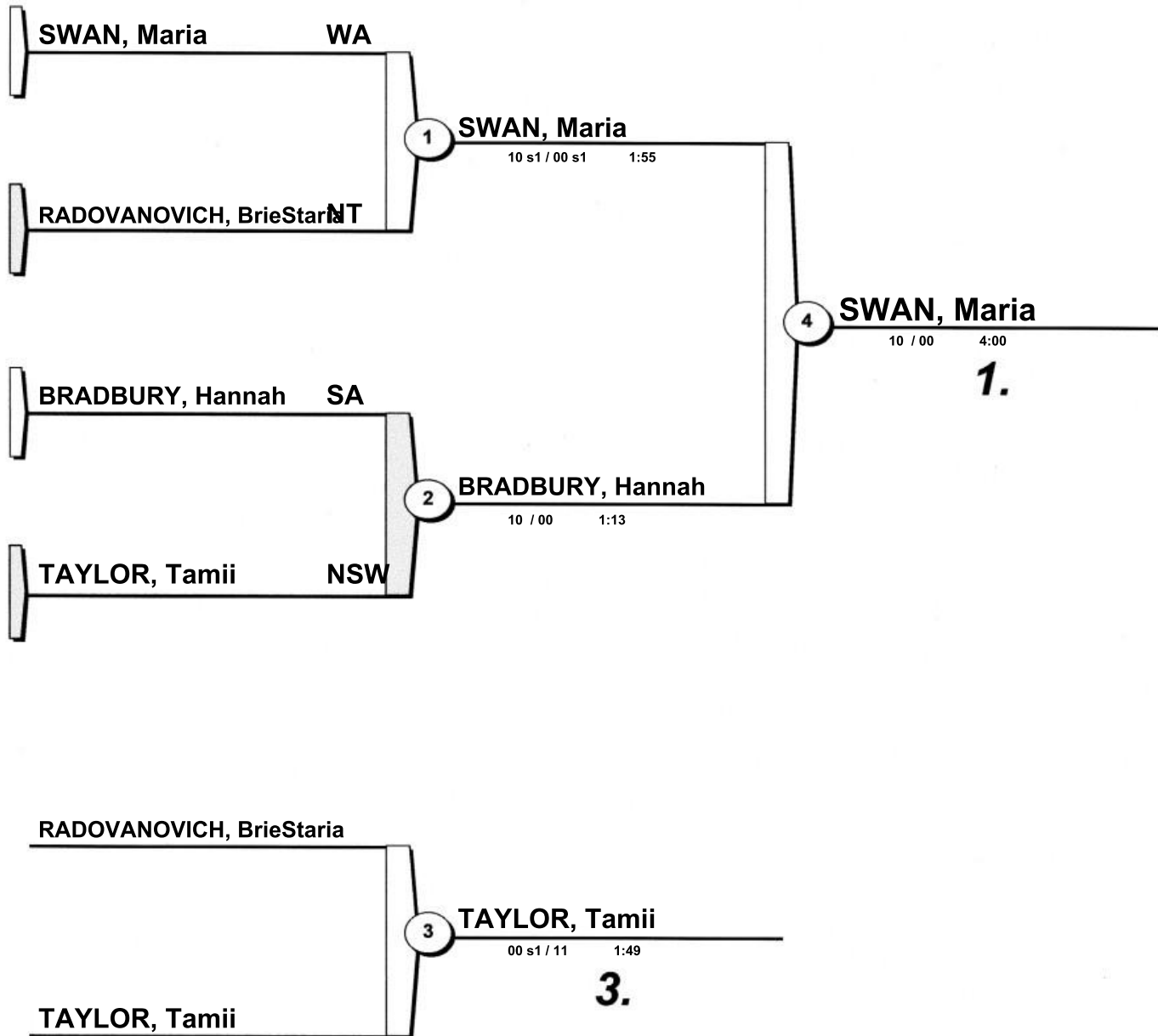

Final Results

- | | |
|---------------------|-----|
| 1. SWAN, Maria | WA |
| 2. BRADBURY, Hannah | SA |
| 3. TAYLOR, Tamii | NSW |

2019 Australian National Championships

Carrara (AUS), 09 Jun 2019

-50 kg

7 Judoka

POOL A

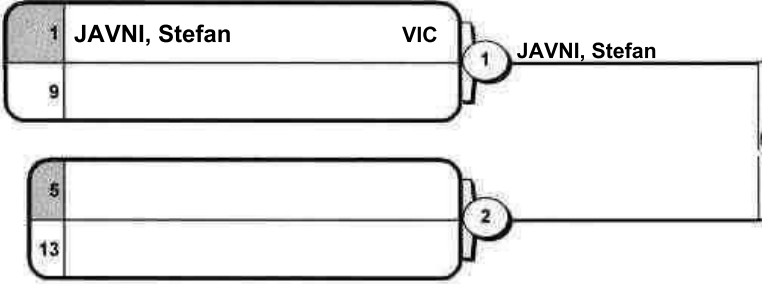

POOL B

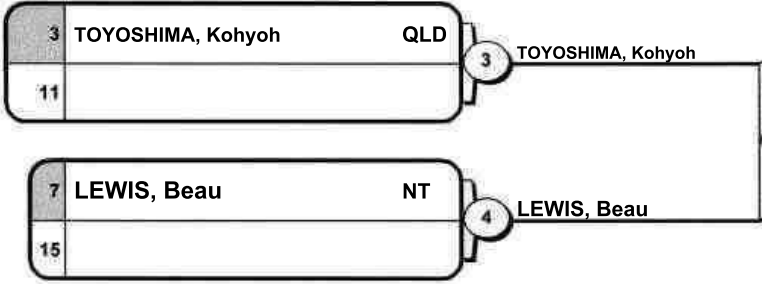

POOL C

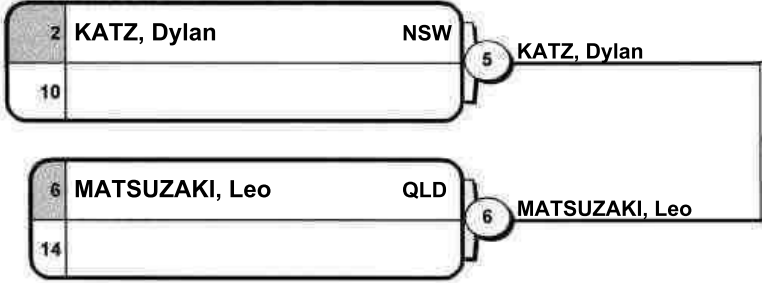

POOL D

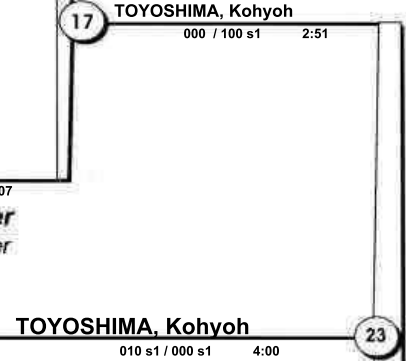
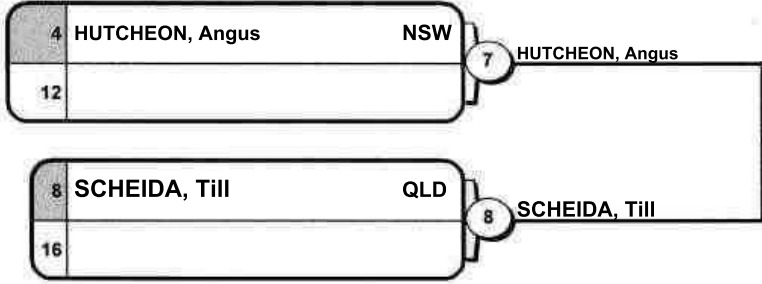

Results		
Résultat / Platzierungen		
1.	TOYOSHIMA, Kohyoh	QLD
2.	KATZ, Dylan	NSW
3.	HUTCHEON, Angus	NSW
3.	JAVNI, Stefan	VIC
5.	LEWIS, Beau	NT
5.	SCHEIDA, Till	QLD
7.	MATSUZAKI, Leo	QLD

Repechage / Trostrunde

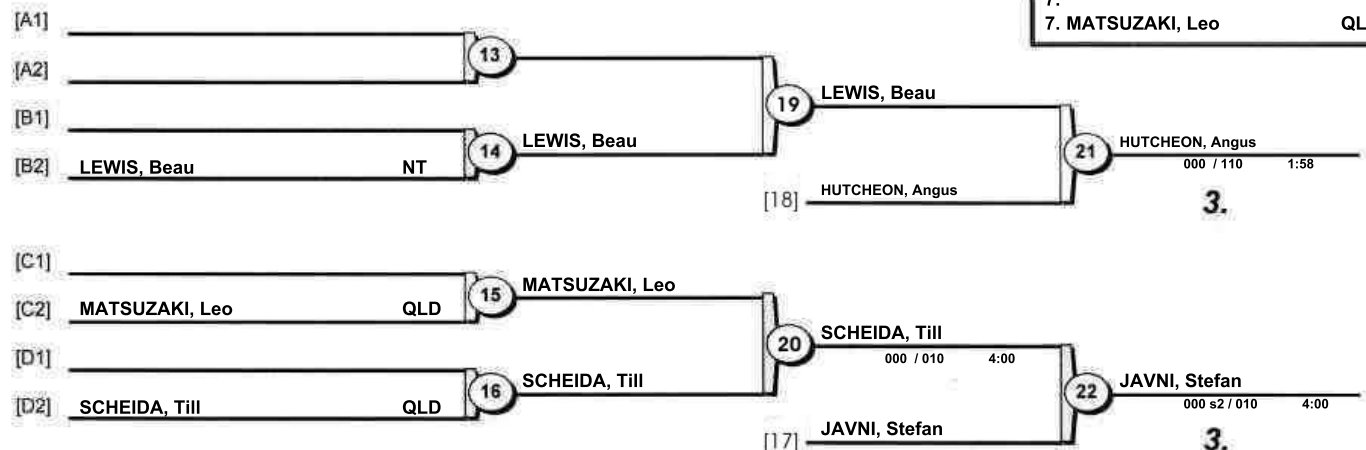

2019 Australian National Championships

Carrara (AUS), 09 Jun 2019

-55 kg

11 Judoka

POOL A

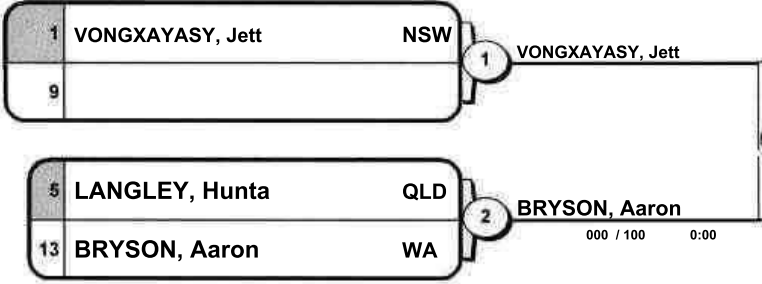

POOL B

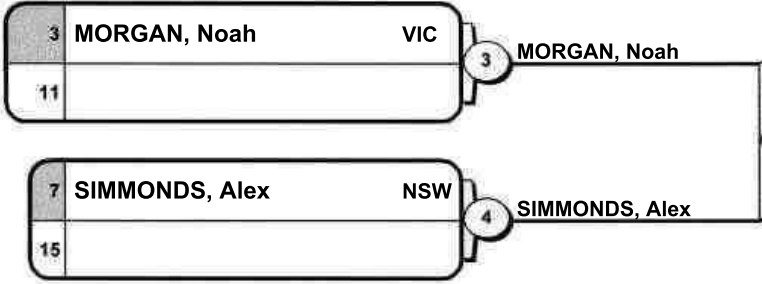

POOL C

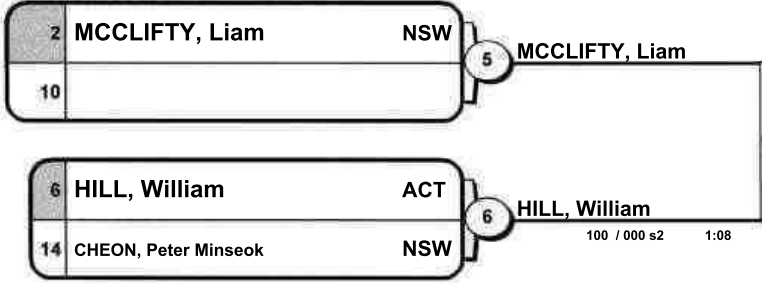

POOL D

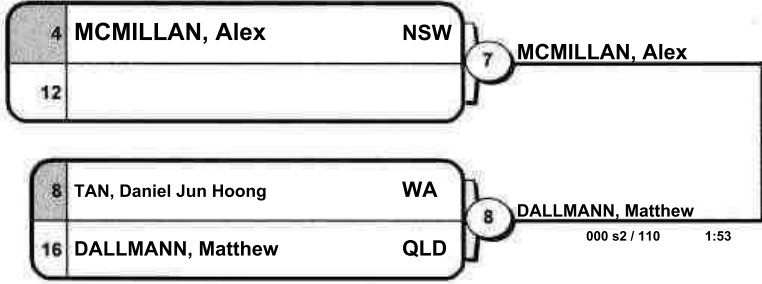

1.

Results	
Résultat / Platzierungen	
1.	VONGXAYASY, Jett NSW
2.	MCCLIFTY, Liam NSW
3.	SIMMONDS, Alex NSW
3.	MORGAN, Noah VIC
5.	DALLMANN, Matthew QLD
5.	HILL, William ACT
7.	BRYSON, Aaron WA
7.	TAN, Daniel Jun Hoong WA

Repechage / Trostrunde

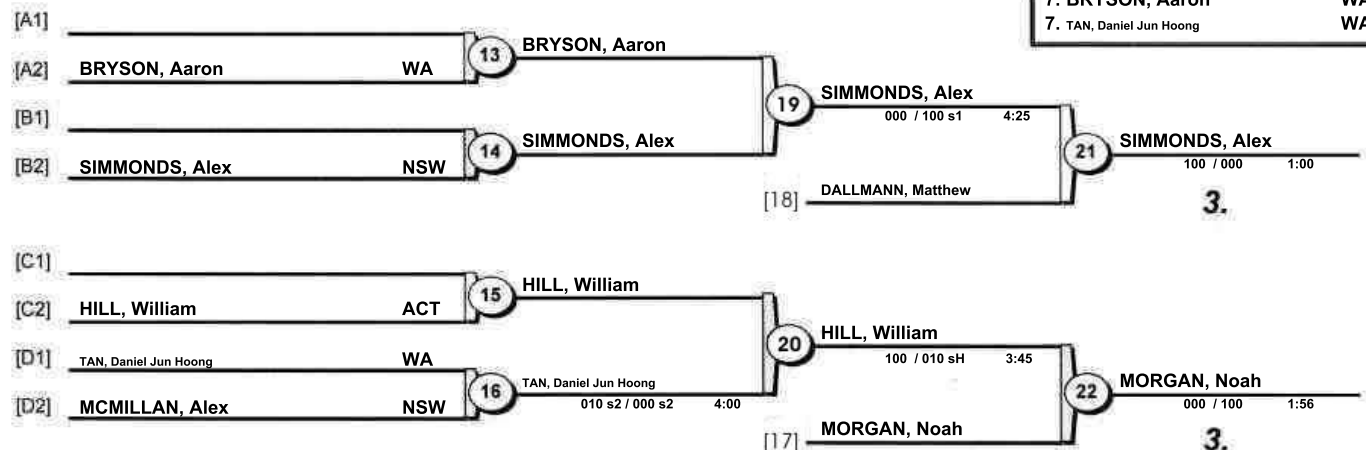

2019 Australian National Championships

Carrara (AUS), 09 Jun 2019

-60 kg

8 Judoka

POOL A

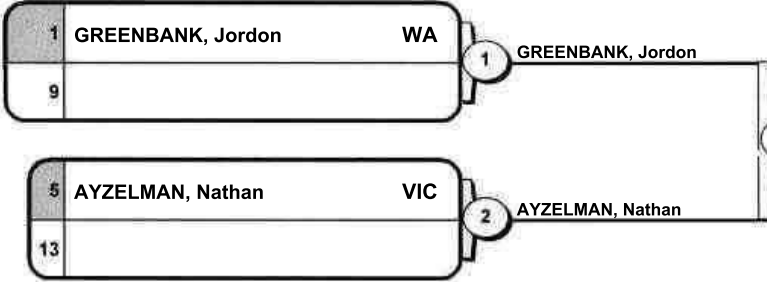

POOL B

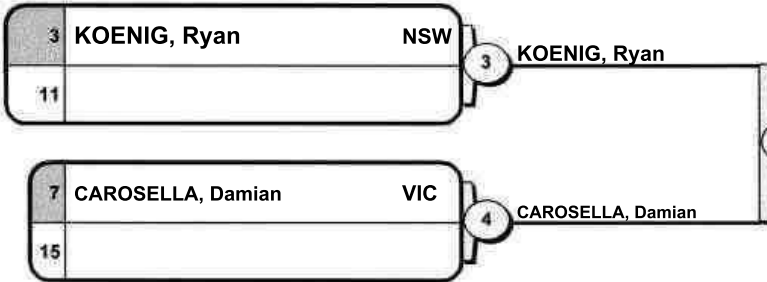

POOL C

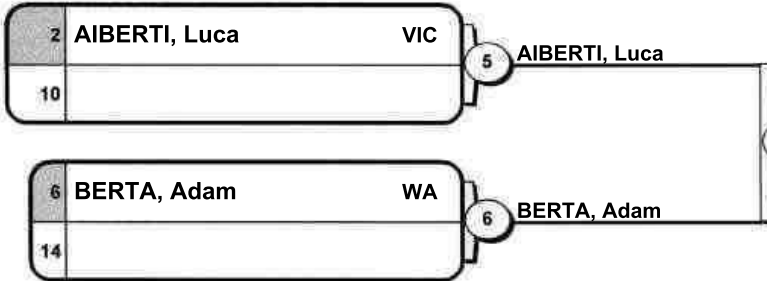

POOL D

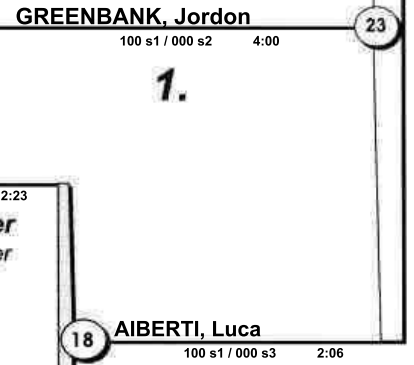
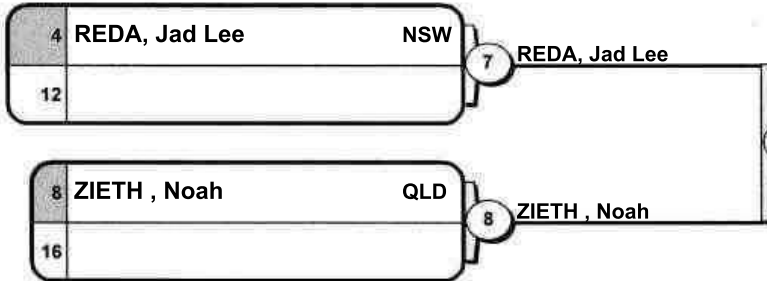

Results	
Résultat / Platzierungen	
1. GREENBANK, Jordon	WA
2. AIBERTI, Luca	VIC
3. REDA, Jad Lee	NSW
3. KOENIG, Ryan	NSW
5. AYZELMAN, Nathan	VIC
5. ZIETH, Noah	QLD
7. CAROSELLA, Damian	VIC
7. BERTA, Adam	WA

Repechage / Trostrunde

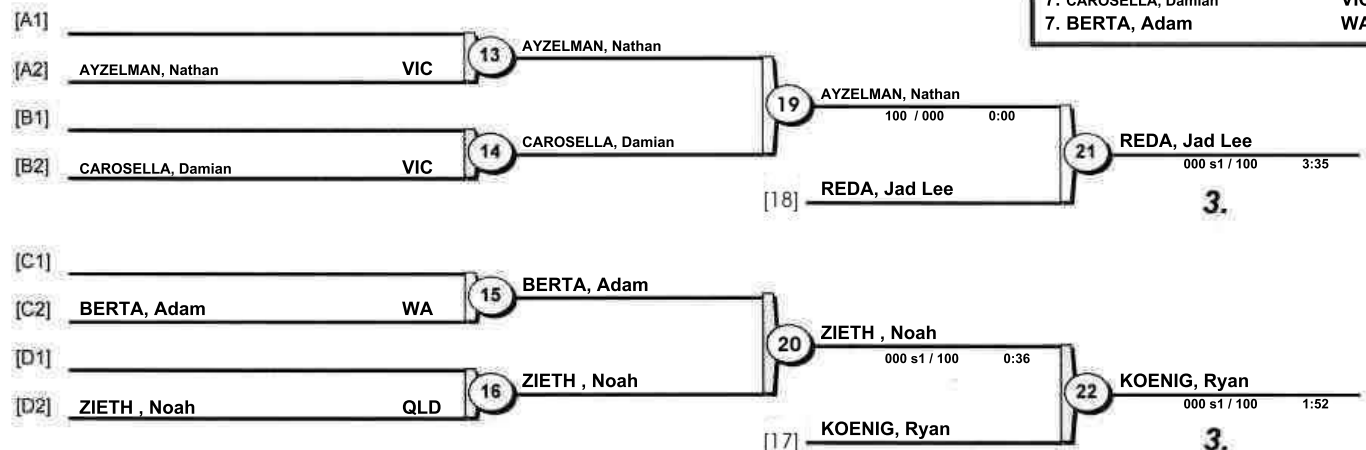

2019 Australian National Championships

Carrara (AUS), 09 Jun 2019

-66 kg

9 Judoka

POOL A

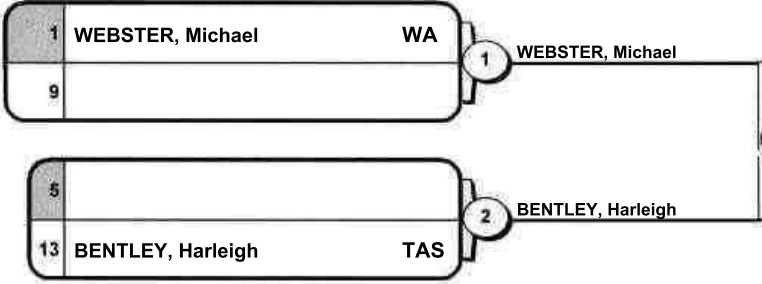

POOL B

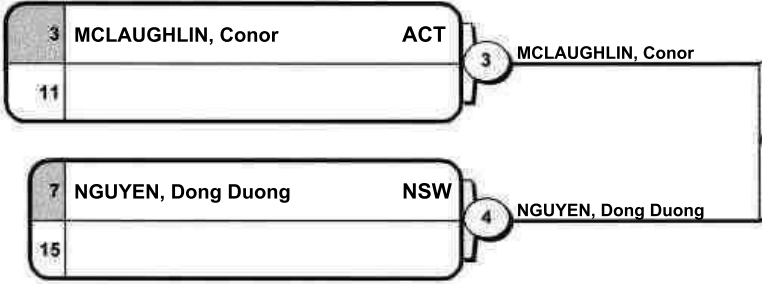

POOL C

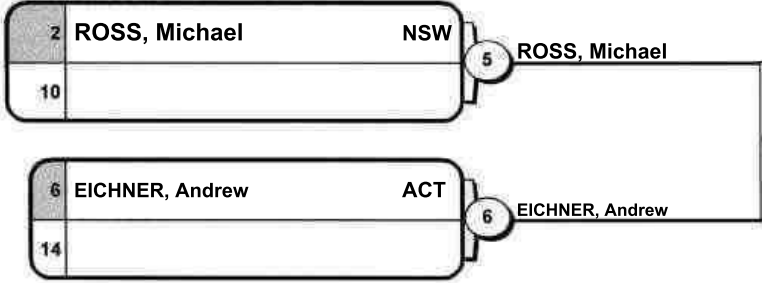

POOL D

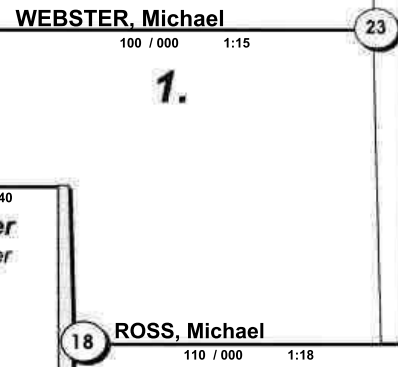
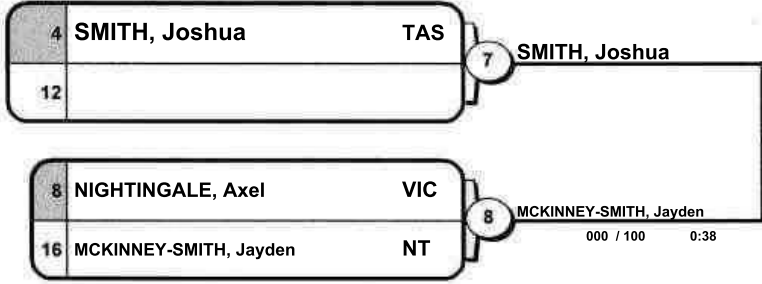

Results	
Résultat / Platzierungen	
1. WEBSTER, Michael	WA
2. ROSS, Michael	NSW
3. MCKINNEY-SMITH, Jayden	NT
3. NGUYEN, Dong Duong	NSW
5. MCLAUGHLIN, Conor	ACT
5. EICHNER, Andrew	ACT
7. BENTLEY, Harleigh	TAS
7. SMITH, Joshua	TAS

Repechage / Trostrunde

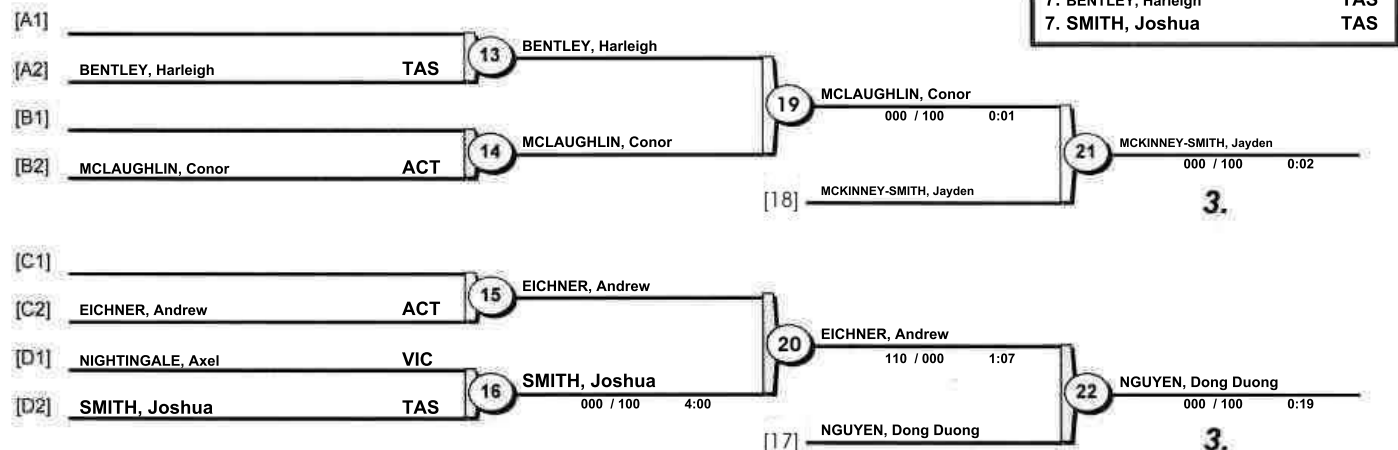

2019 Australian National Championships

Carrara (AUS), 09 Jun 2019

-73 kg

8 Judoka

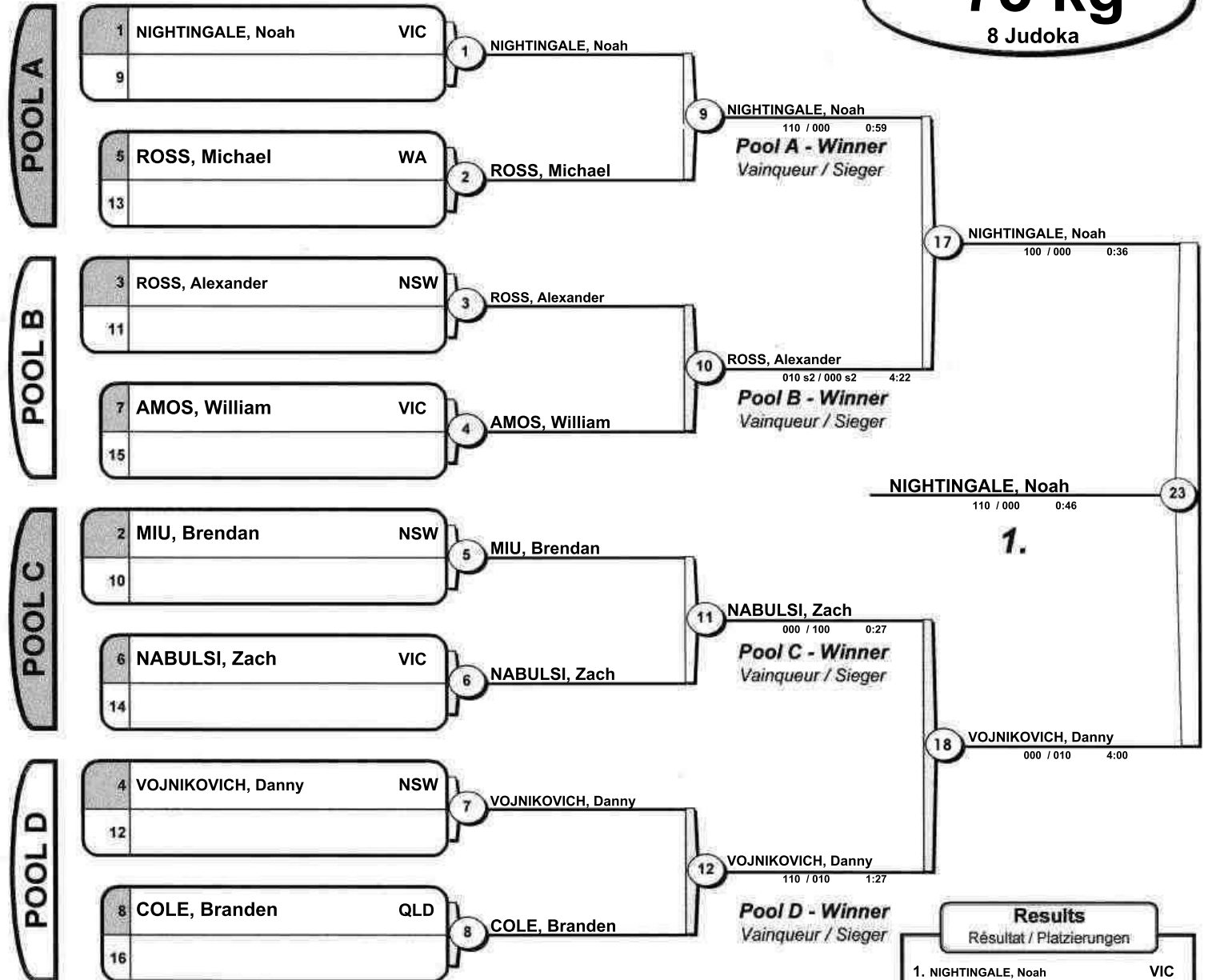

Results		
Résultat / Platzierungen		
1.	NIGHTINGALE, Noah	VIC
2.	VOJNIKOVICH, Danny	NSW
3.	ROSS, Michael	WA
3.	MIU, Brendan	NSW
5.	NABULSI, Zach	VIC
5.	ROSS, Alexander	NSW
7.	AMOS, William	VIC
7.	COLE, Branden	QLD

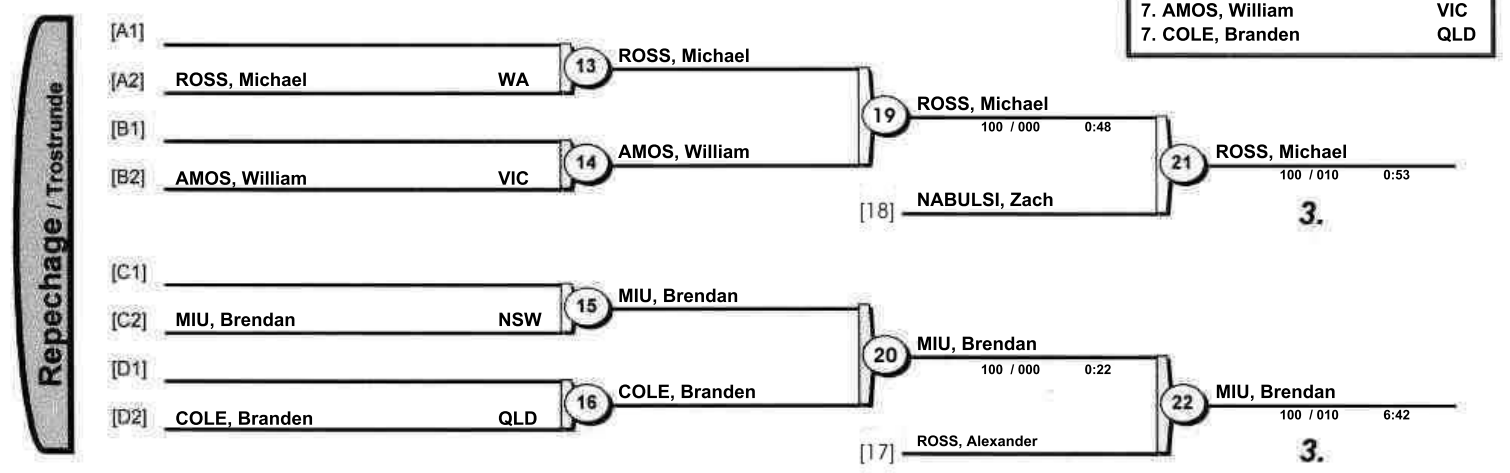

2019 Australian National Championships

Carrara (AUS), 09 Jun 2019

-81 kg

4 Judoka

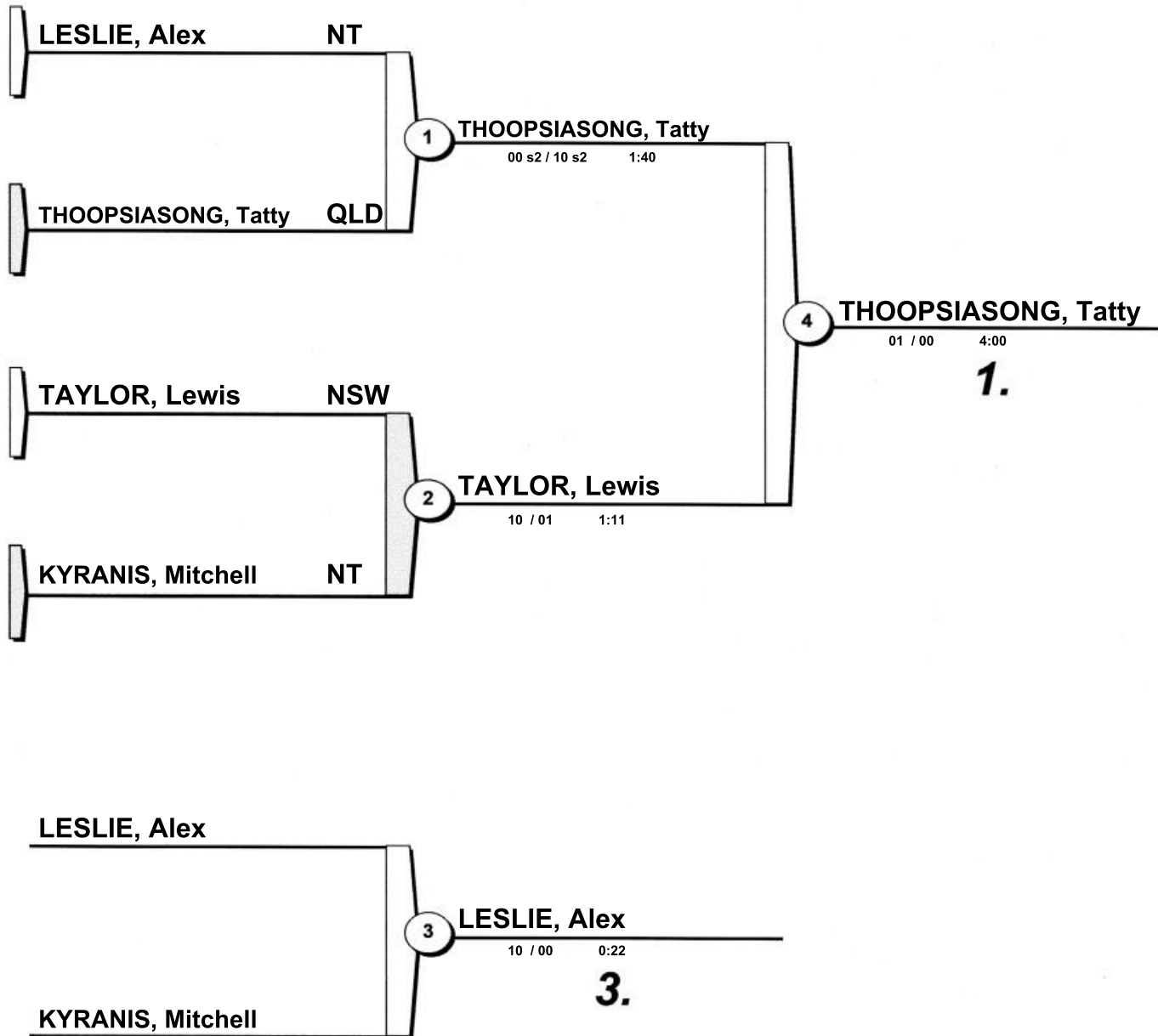

Final Results

1. THOOPSIASONG, Tatty QLD
2. TAYLOR, Lewis NSW
3. LESLIE, Alex NT

2019 Australian National Championships

Carrara (AUS), 09 Jun 2019

-90 kg

2 Judoka

BEST OF THREE

1	SPILLANE, Liam	NSW	1	SPILLANE, Liam	NSW	10 / 00 s1	4:00
2	NGAATA, Micqut	NSW					

1	SPILLANE, Liam	NSW	2	SPILLANE, Liam	NSW	11 / 00	1:42
2	NGAATA, Micqut	NSW					

1	SPILLANE, Liam	NSW	3	SPILLANE, Liam	NSW	10 / 00	0:00
2	NGAATA, Micqut	NSW					

Final Results

1. SPILLANE, Liam NSW
2. NGAATA, Micqut NSW

2019 Australian National Championships

Carrara (AUS), 09 Jun 2019

-48 kg

7 Judoka

POOL A

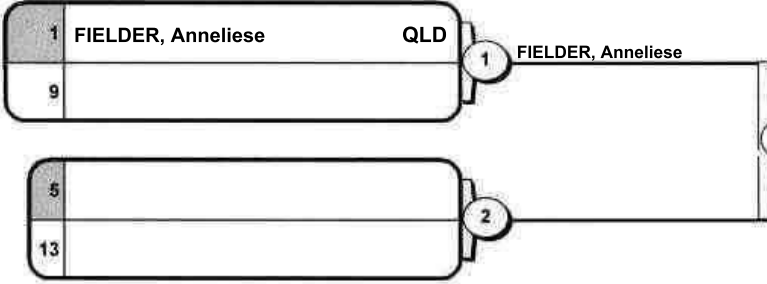

POOL B

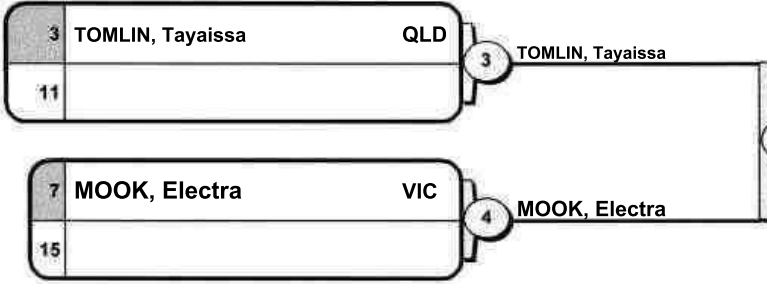

POOL C

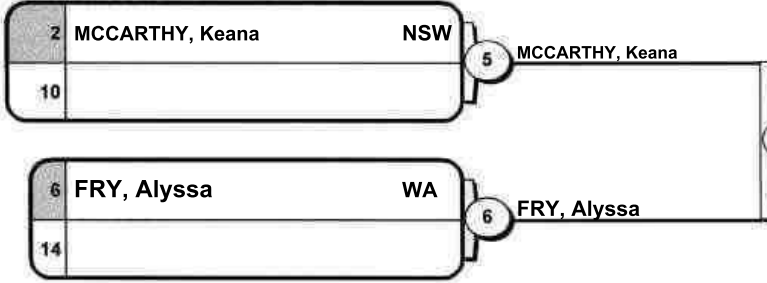

POOL D

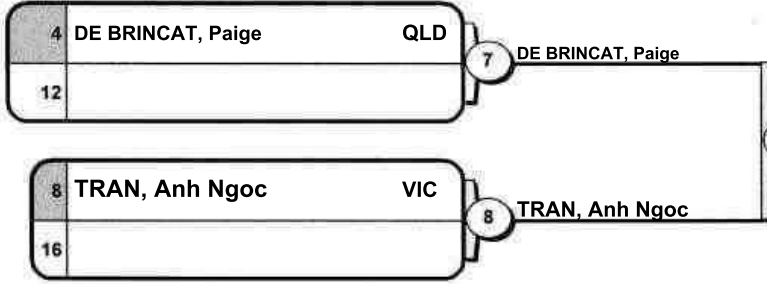

FIELDER, Anneliese
100 / 000 0:09

1.

Results	
Résultat / Platzierungen	
1. FIELDER, Anneliese	QLD
2. MCCARTHY, Keana	NSW
3. MOOK, Electra	VIC
3. FRY, Alyssa	WA
5. DE BRINCAT, Paige	QLD
5. TOMLIN, Tayaiassa	QLD
7.	
7. TRAN, Anh Ngoc	VIC

Repechage / Trostrunde

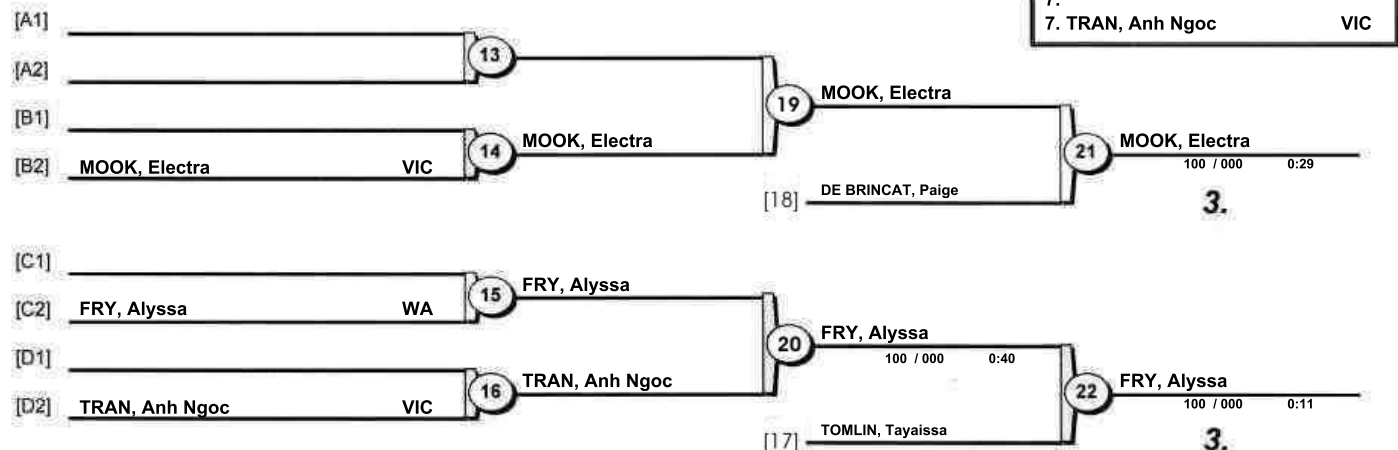

2019 Australian National Championships

Carrara (AUS), 09 Jun 2019

-52 kg

6 Judoka

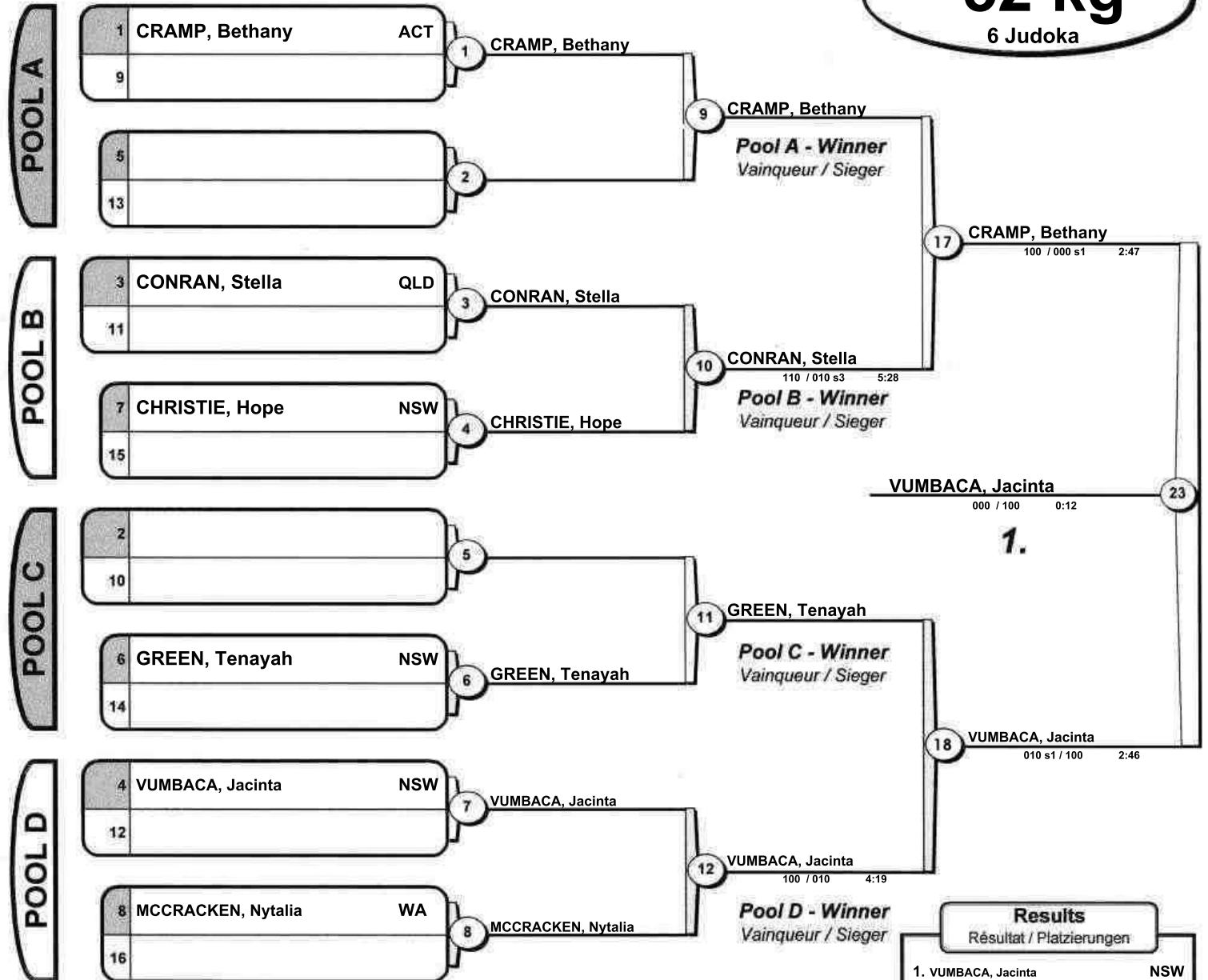

Results	
Résultat / Platzierungen	
1.	VUMBACA, Jacinta NSW
2.	CRAMP, Bethany ACT
3.	GREEN, Tenayah NSW
3.	MCCRACKEN, Nytalia WA
5.	CHRISTIE, Hope NSW
5.	CONRAN, Stella QLD
7.	
7.	

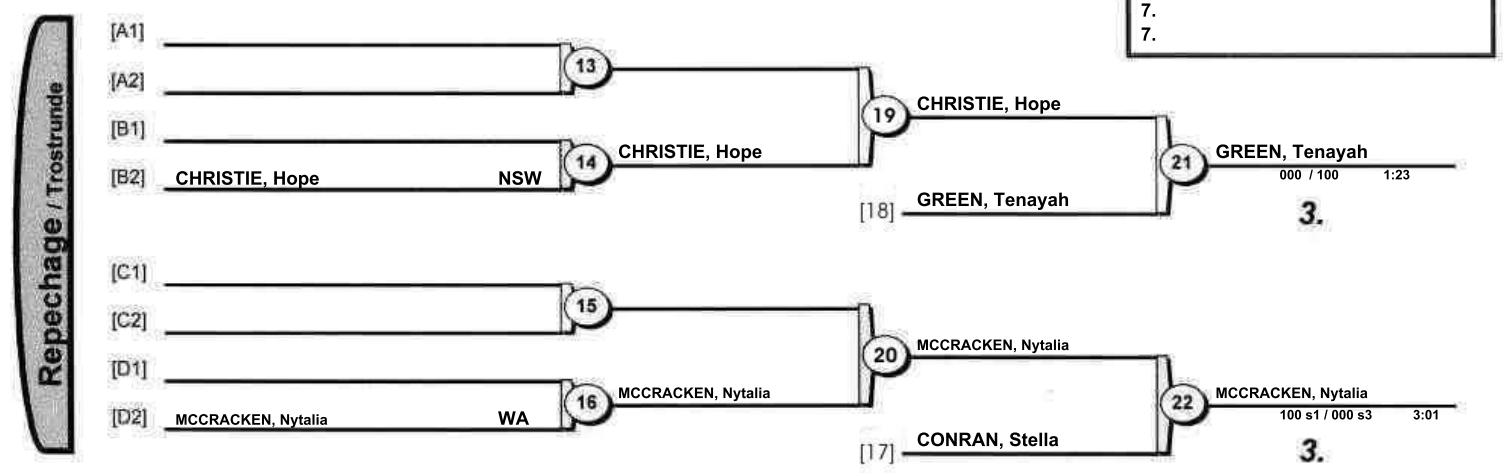

2019 Australian National Championships

Carrara (AUS), 09 Jun 2019

-57 kg

6 Judoka

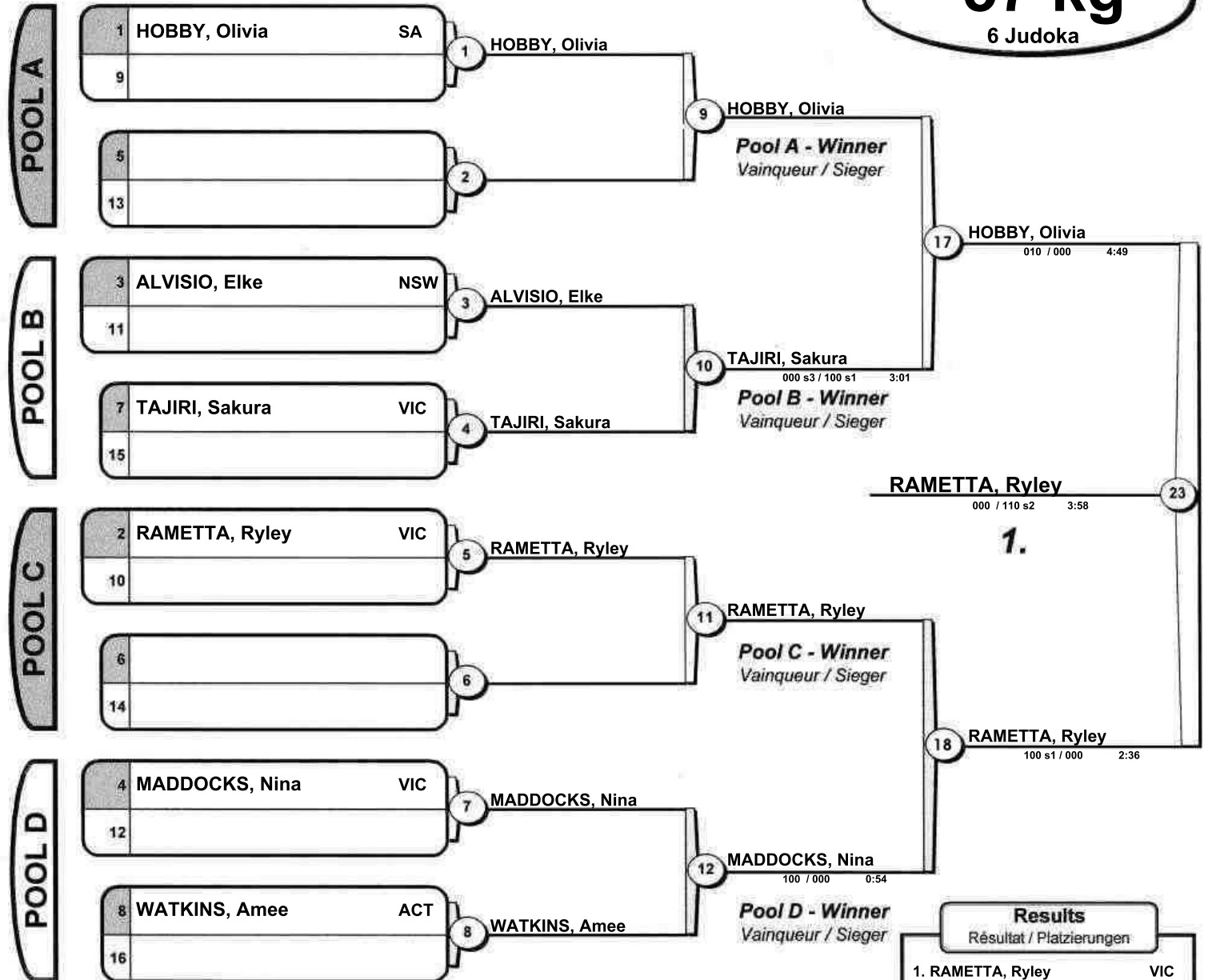

Results	
Résultat / Platzierungen	
1.	RAMETTA, Ryley VIC
2.	HOBBY, Olivia SA
3.	ALVISIO, Elke NSW
3.	TAJIRI, Sakura VIC
5.	MADDOCKS, Nina VIC
5.	WATKINS, Amee ACT
7.	
7.	

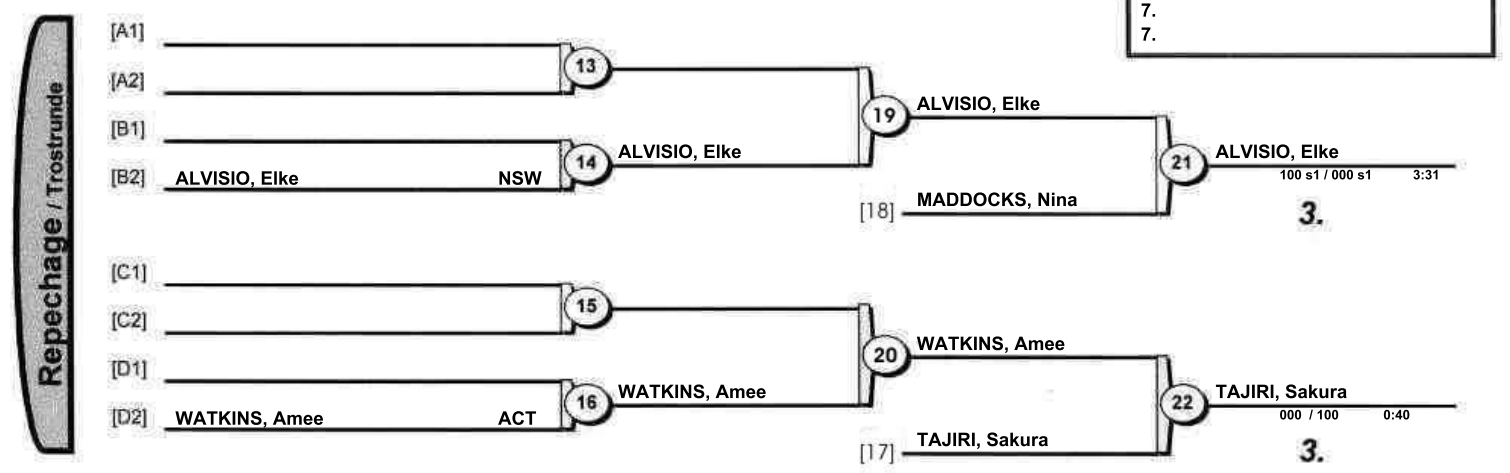

2019 Australian National Championships

Carrara (AUS), 09 Jun 2019

-63 kg

5 Judoka

	1	3	5	Wins Score	
1 ROBERTS, Tammin TAS		0	0	0 0	
3 MIDDLETON, Saya WA	1		1	2 0	
5 WIGHTMAN, Indi NSW	1	0		1 0	

	2	4	Wins	Scores
2 BROTHERS, Saskia NSW		1		(0)
4 HADDOW, Josephine WA	0			(0)

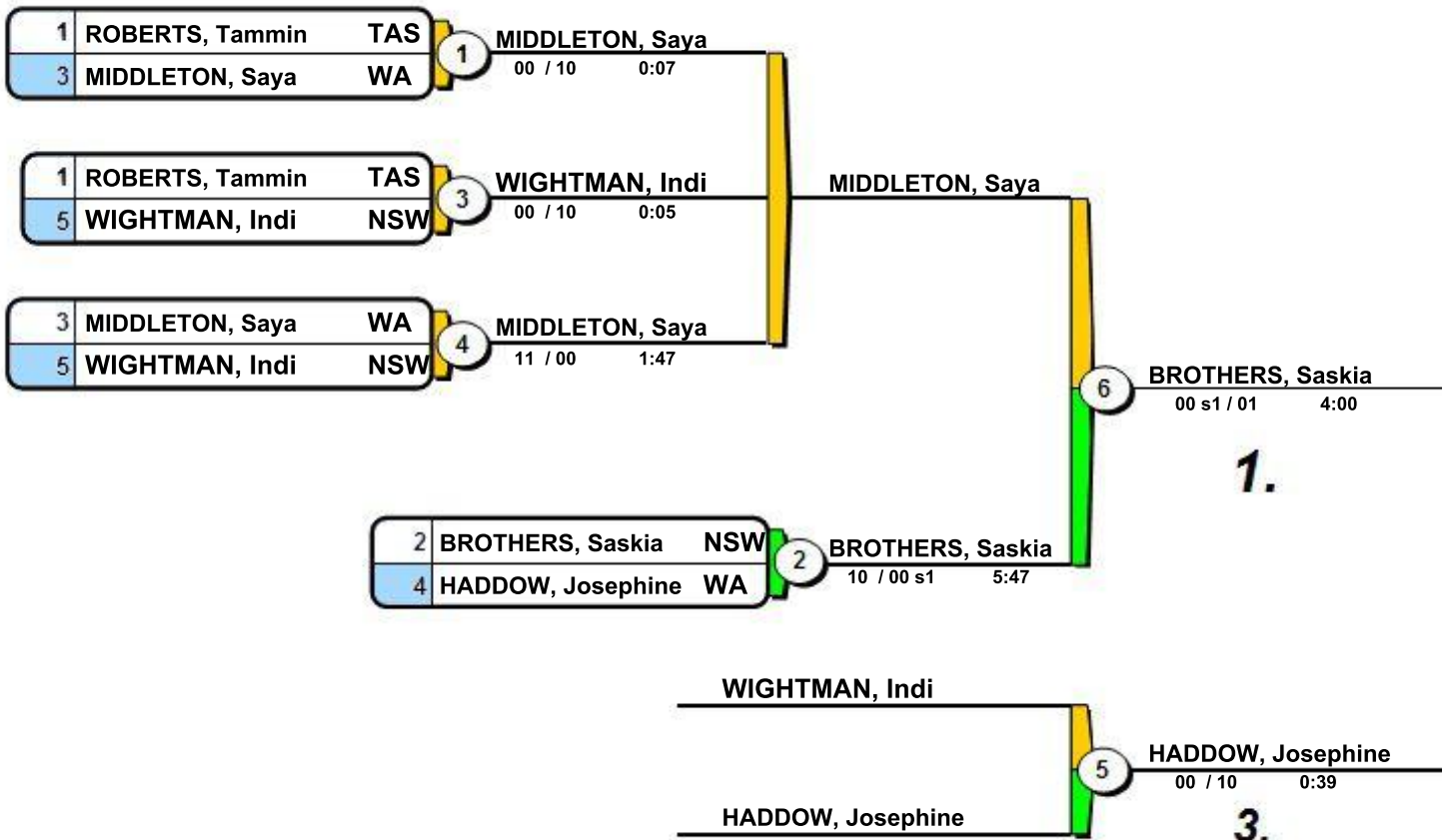

Final Results

1. BROTHERS, Saskia NSW
2. MIDDLETON, Saya WA
3. HADDOW, Josephine WA

2019 Australian National Championships

Carrara (AUS), 09 Jun 2019

-70 kg

4 Judoka

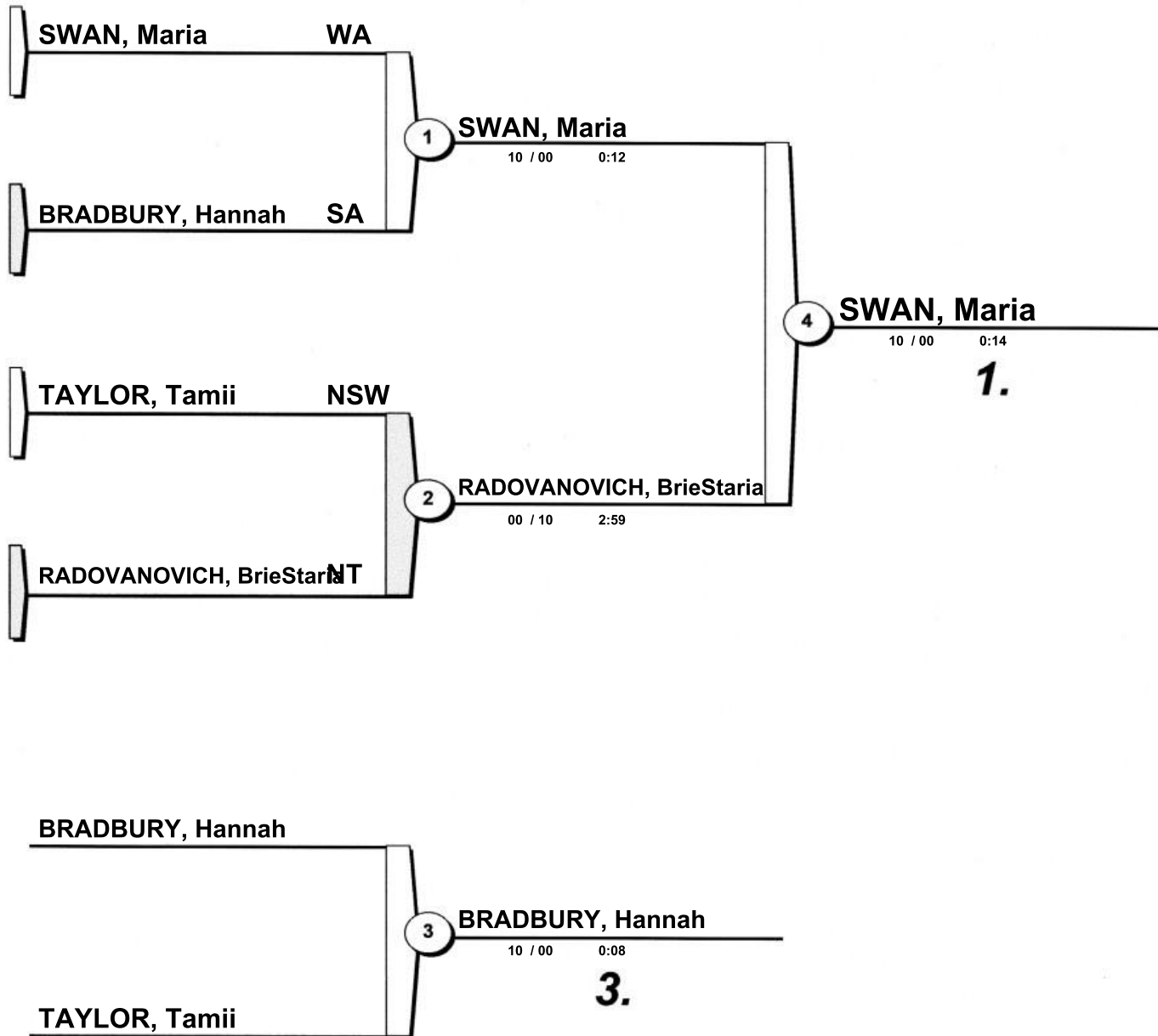

Final Results

1. SWAN, Maria WA
2. RADOVANOVIICH, BrieStaria NT
3. BRADBURY, Hannah SA

2019 Australian National Championships

Carrara (AUS), 08 Jun 2019

-32B kg

5 Judoka

	1	3	5	Wins Score	
1 TAI TIN, Ethan VIC		1	1	2 0	
3 DUNCAN, Price QLD	0		1	1 0	
5 GOLDTHORPE, Sean NSW	0	0		0 0	

	2	4	Wins	Scores
2 ANSHTEIN, Yonatan VIC		1		(0)
4 CAI, Demin NSW	0			(0)

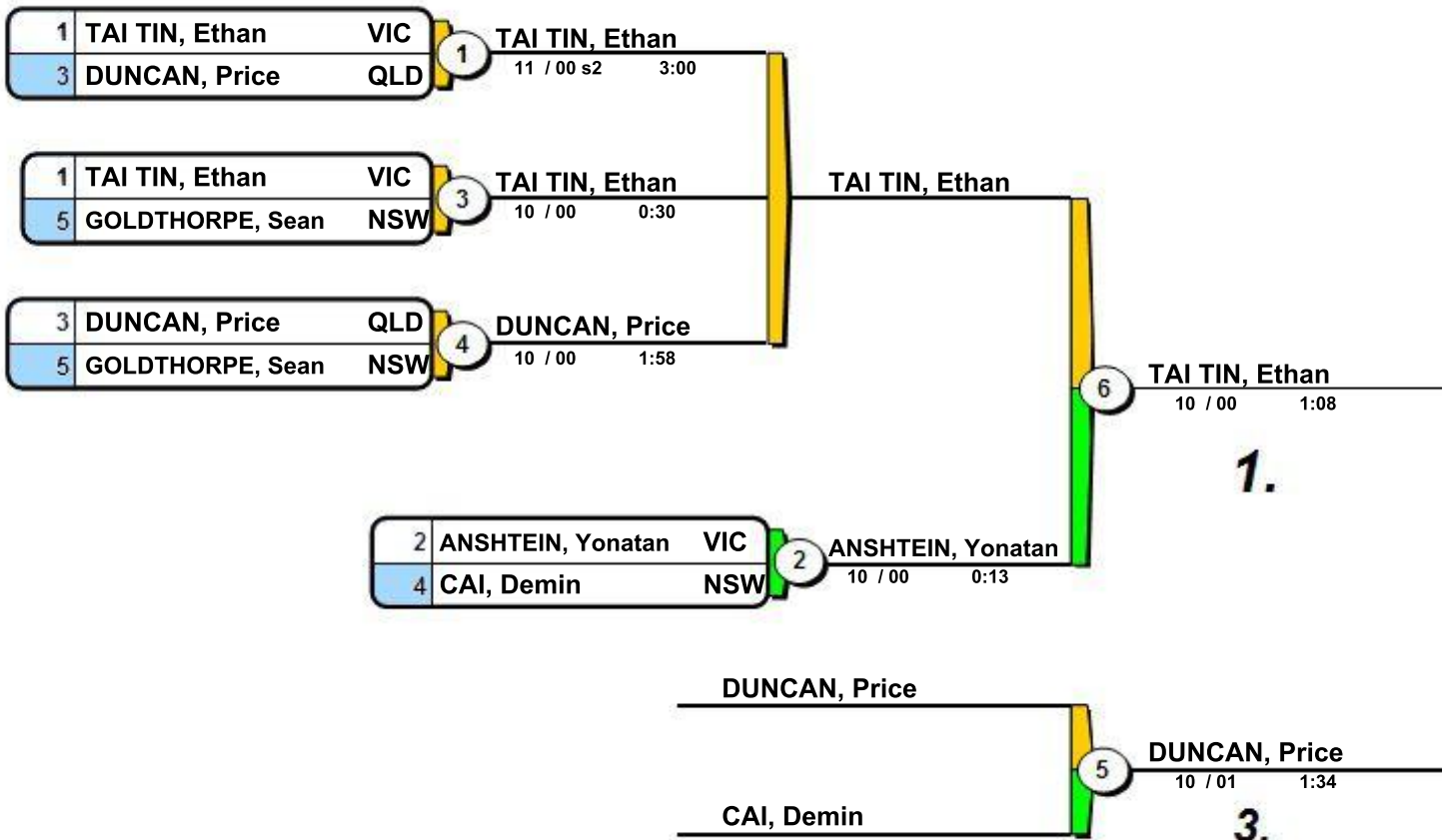

Final Results

1. TAI TIN, Ethan VIC
2. ANSHTEIN, Yonatan VIC
3. DUNCAN, Price QLD

2019 Australian National Championships

Carrara (AUS), 08 Jun 2019

-36B kg

6 Judoka

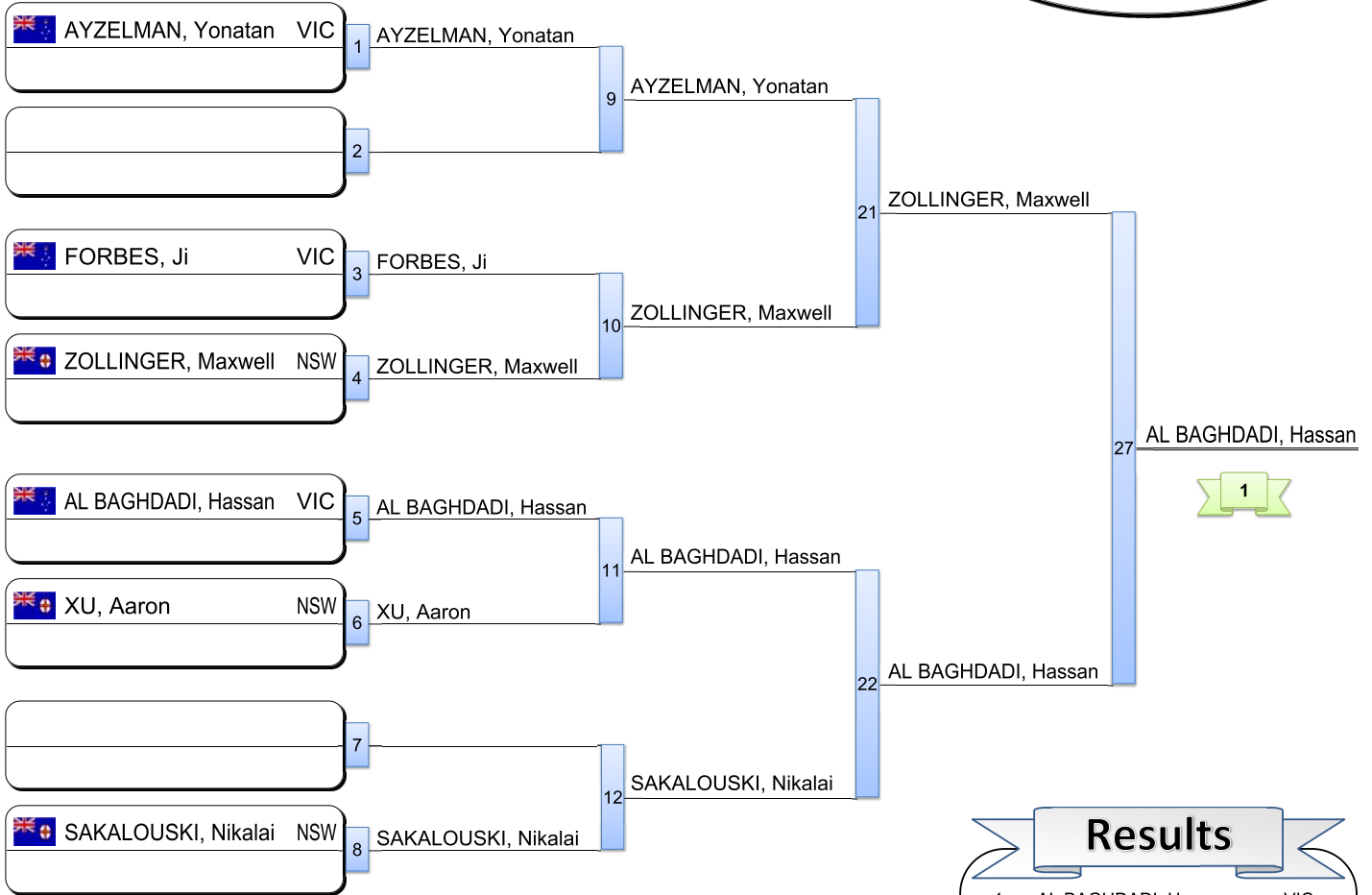

Results		
1.	AL BAGHDADI, Hassan	VIC
2.	ZOLLINGER, Maxwell	NSW
3.	FORBES, Ji	VIC
3.	AYZELMAN, Yonatan	VIC
5.	SAKALOUSKI, Nikalai	NSW
5.	XU, Aaron	NSW
7.		
7.		

Repechage

Loser contest will appear at in repechage

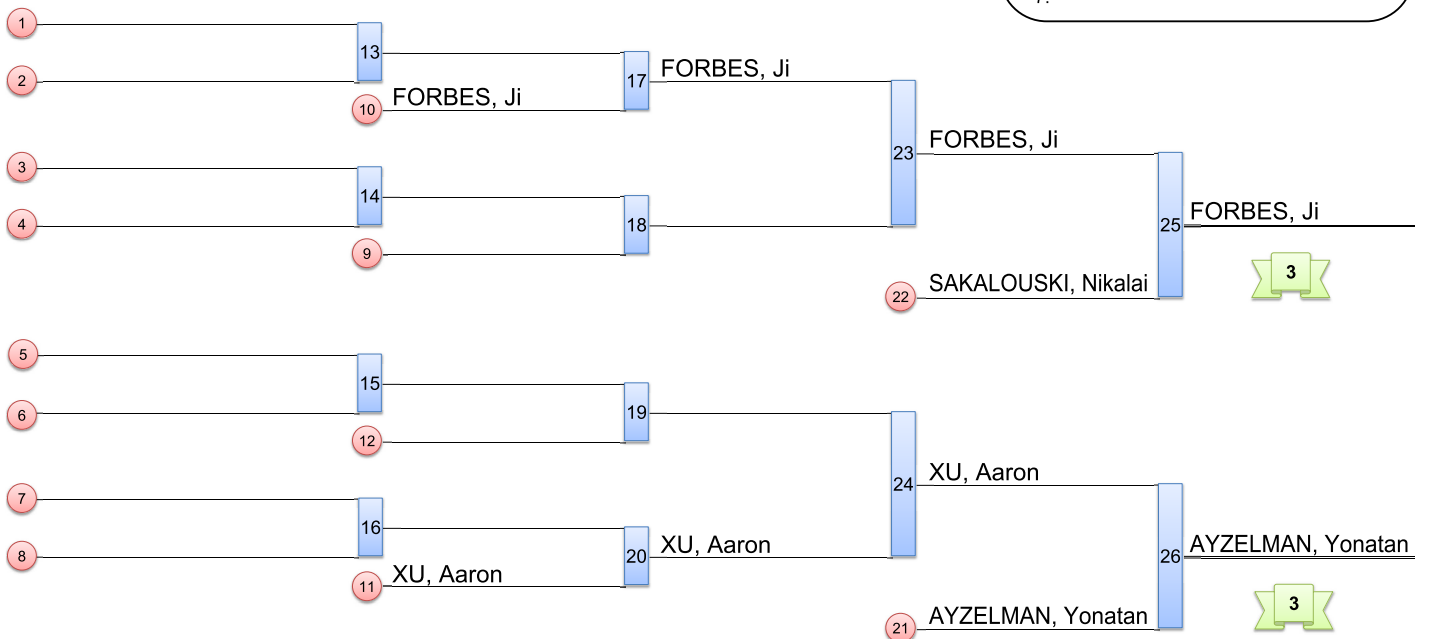

2019 Australian National Championships

Carrara (AUS), 08 Jun 2019

-40B kg

19 Judoka

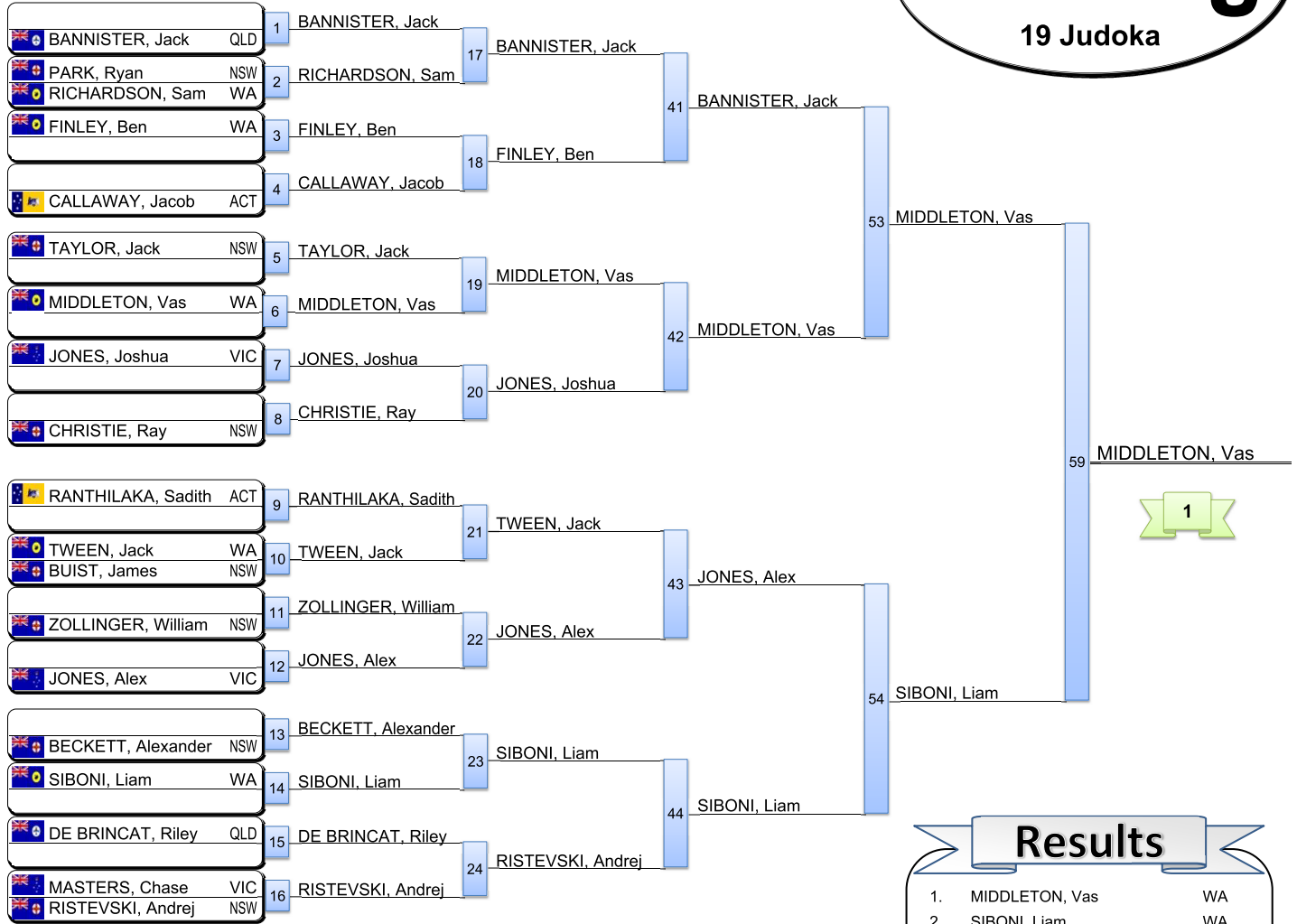

Results

- | | | |
|----|--------------------|-----|
| 1. | MIDDLETON, Vas | WA |
| 2. | SIBONI, Liam | WA |
| 3. | TAYLOR, Jack | NSW |
| 3. | ZOLLINGER, William | NSW |
| 5. | JONES, Alex | VIC |
| 5. | BANNISTER, Jack | QLD |
| 7. | JONES, Joshua | VIC |
| 7. | DE BRINCAT, Riley | QLD |

Repechage

Loser contest will appear at in repechage

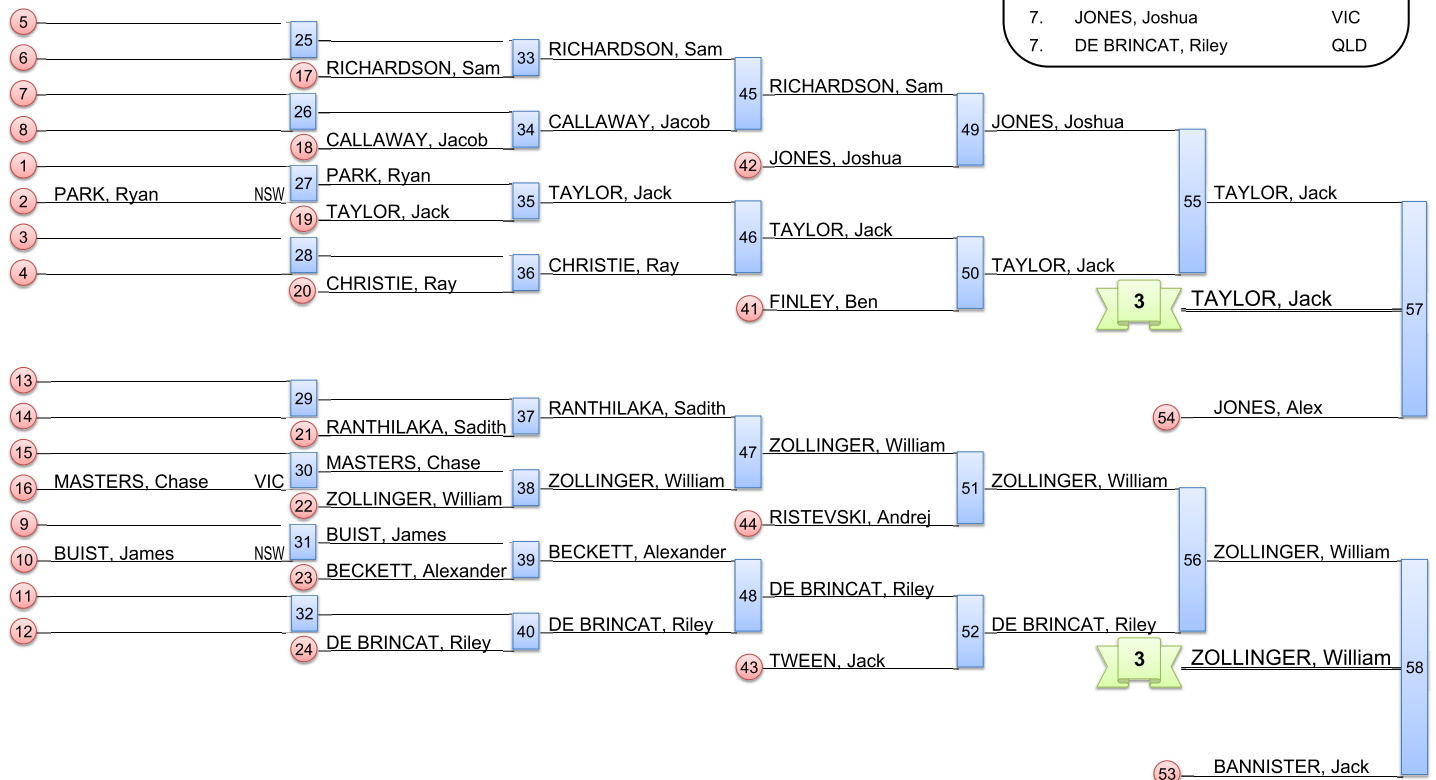

2019 Australian National Championships

Carrara (AUS), 08 Jun 2019

-45 kg

21 Judoka

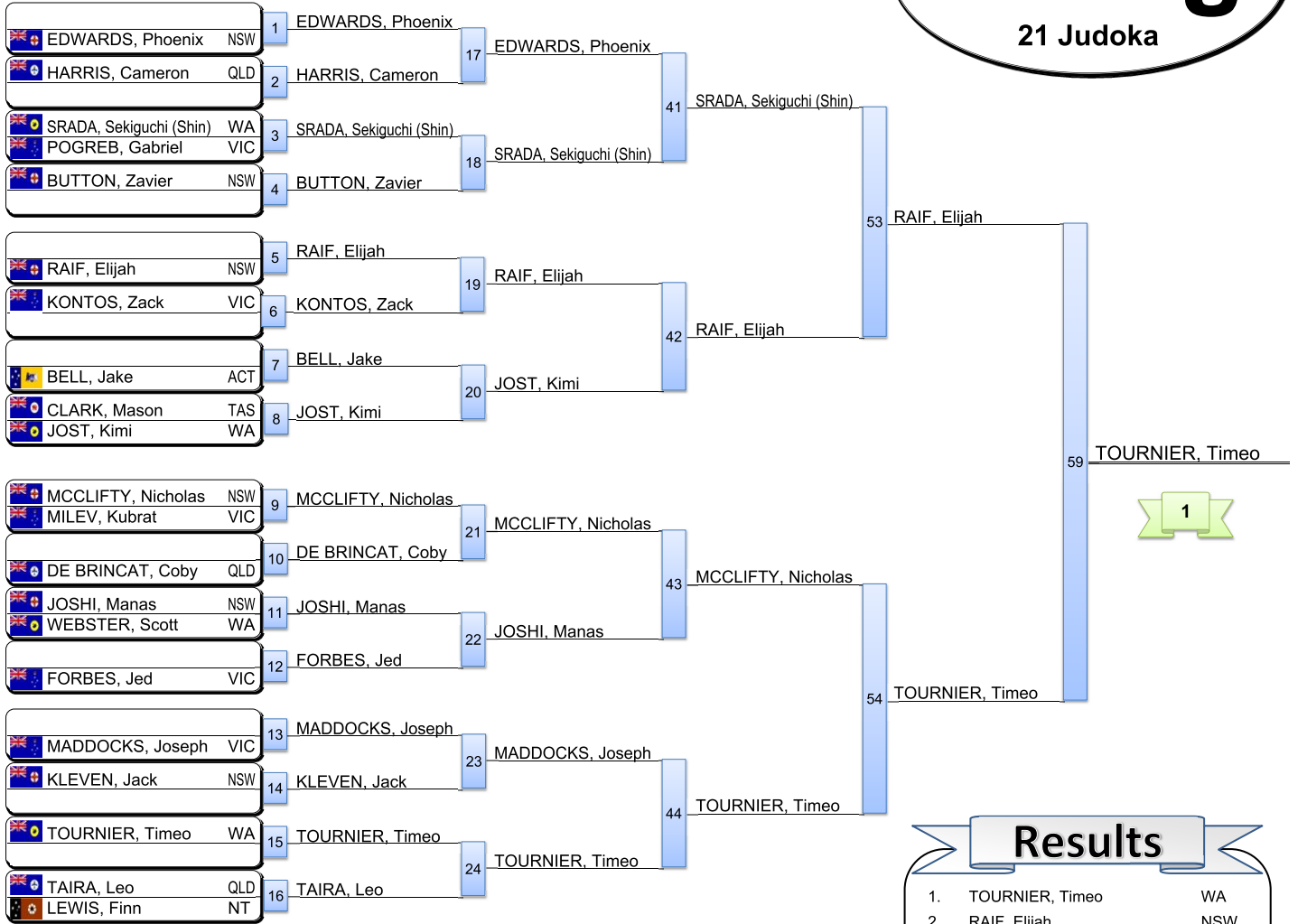

Repechage

Loser contest will appear at in repechage

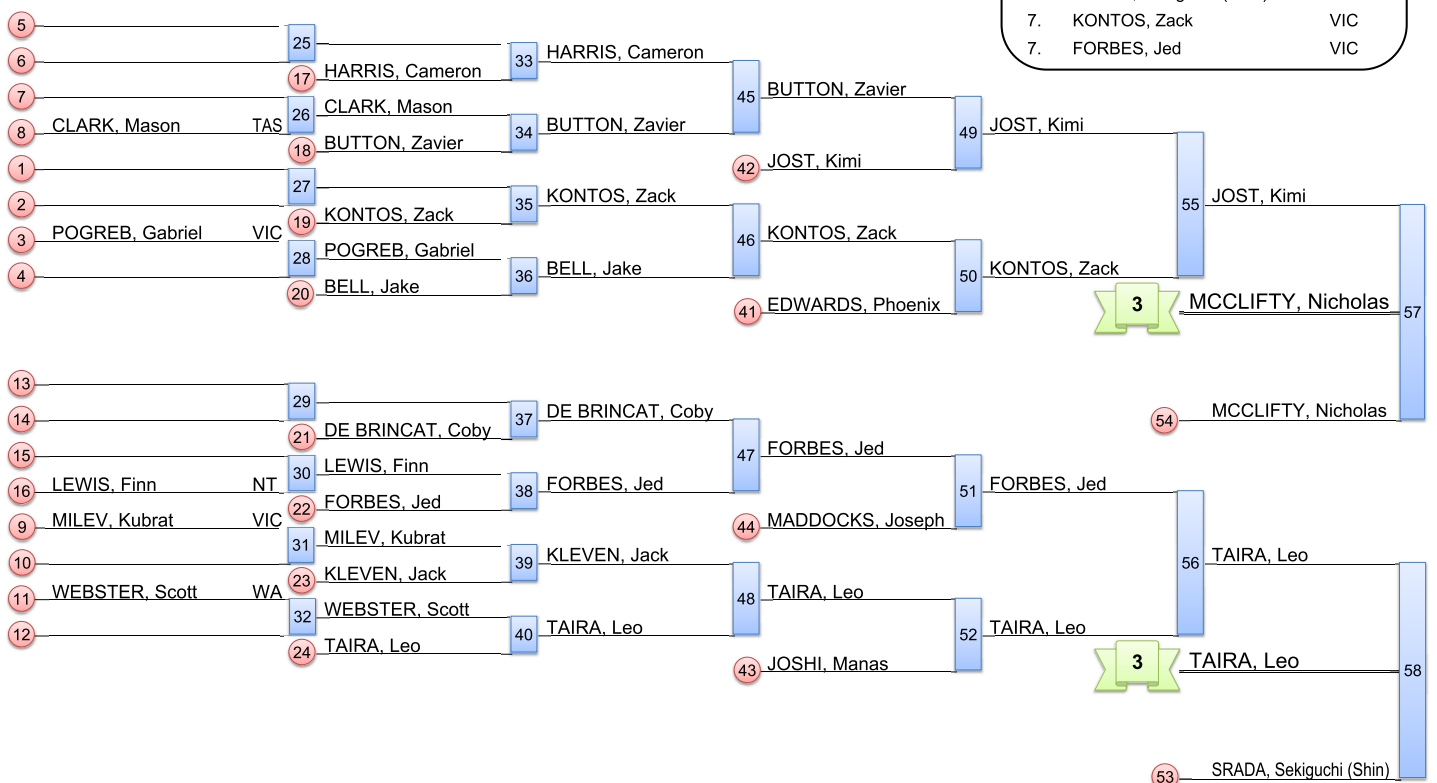

2019 Australian National Championships

Carrara (AUS), 08 Jun 2019

-50 kg

19 Judoka

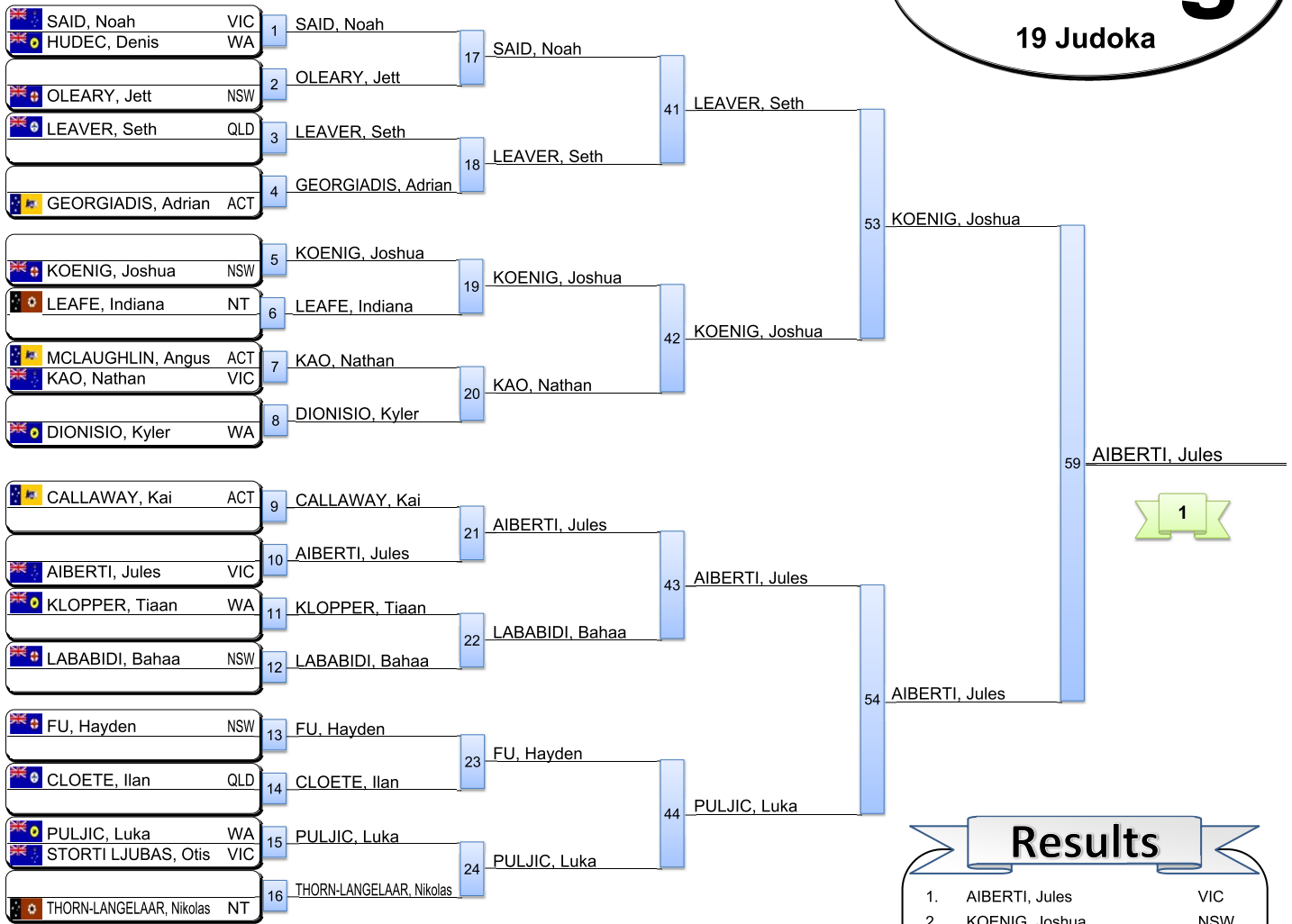

Repechage

Loser contest will appear at in repechage

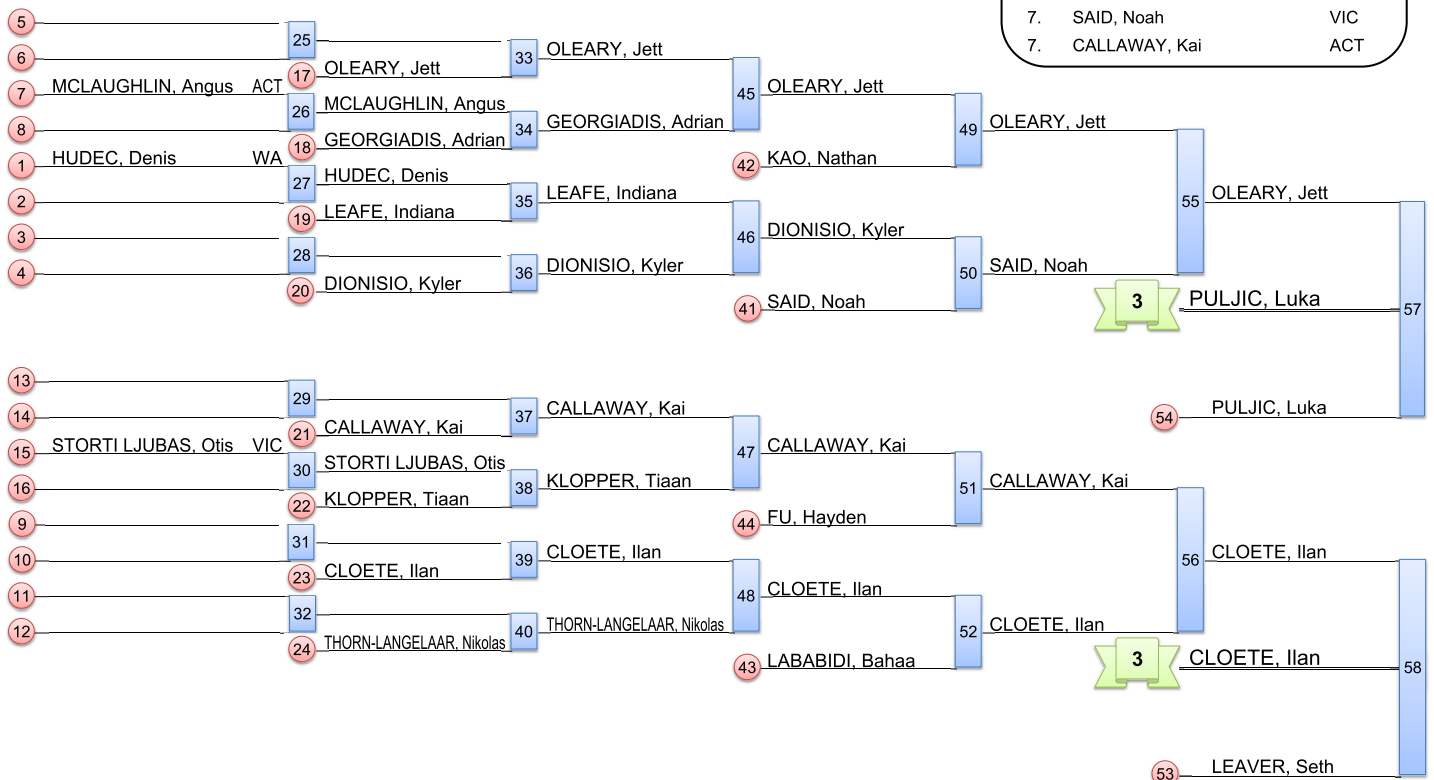

2019 Australian National Championships

Carrara (AUS), 08 Jun 2019

-55 kg

12 Judoka

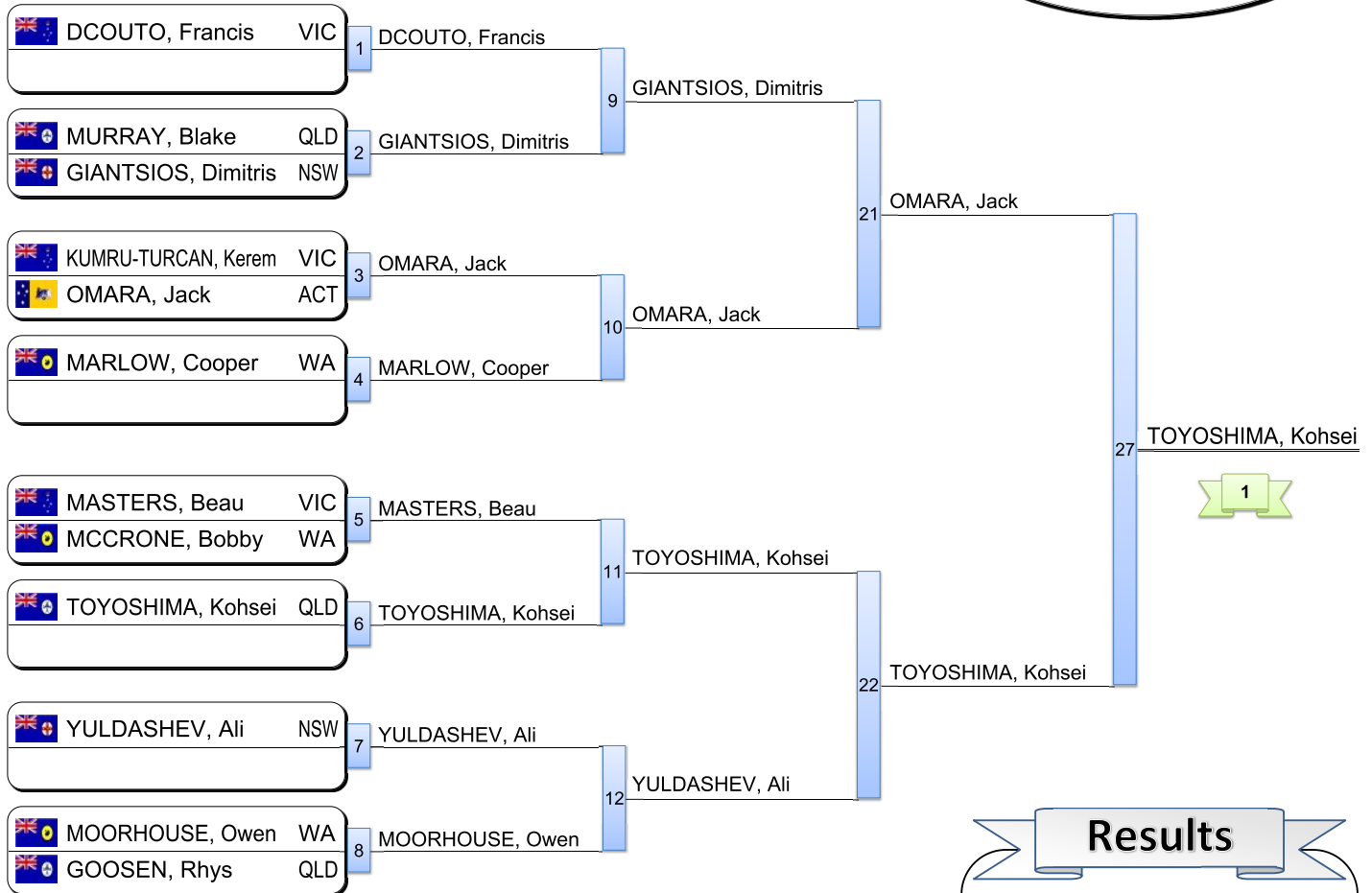

Repechage

Loser contest will appear at in repechage

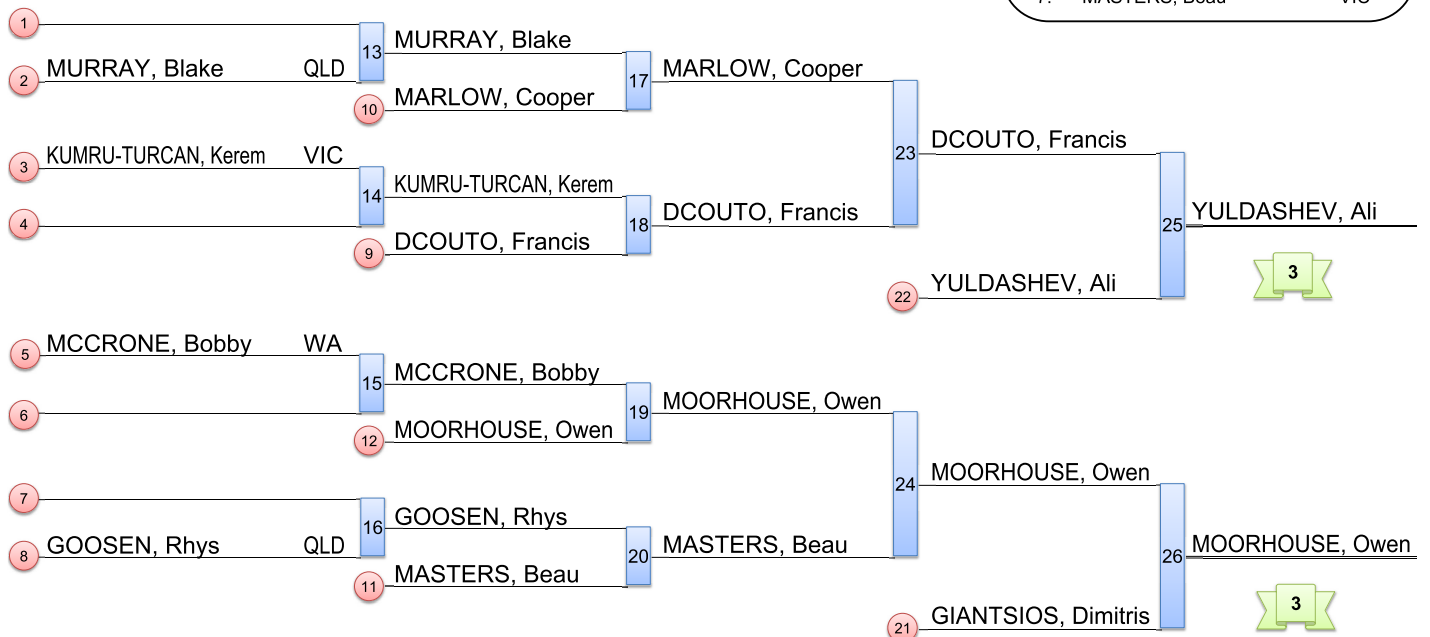

2019 Australian National Championships

Carrara (AUS), 08 Jun 2019

-60 kg

8 Judoka

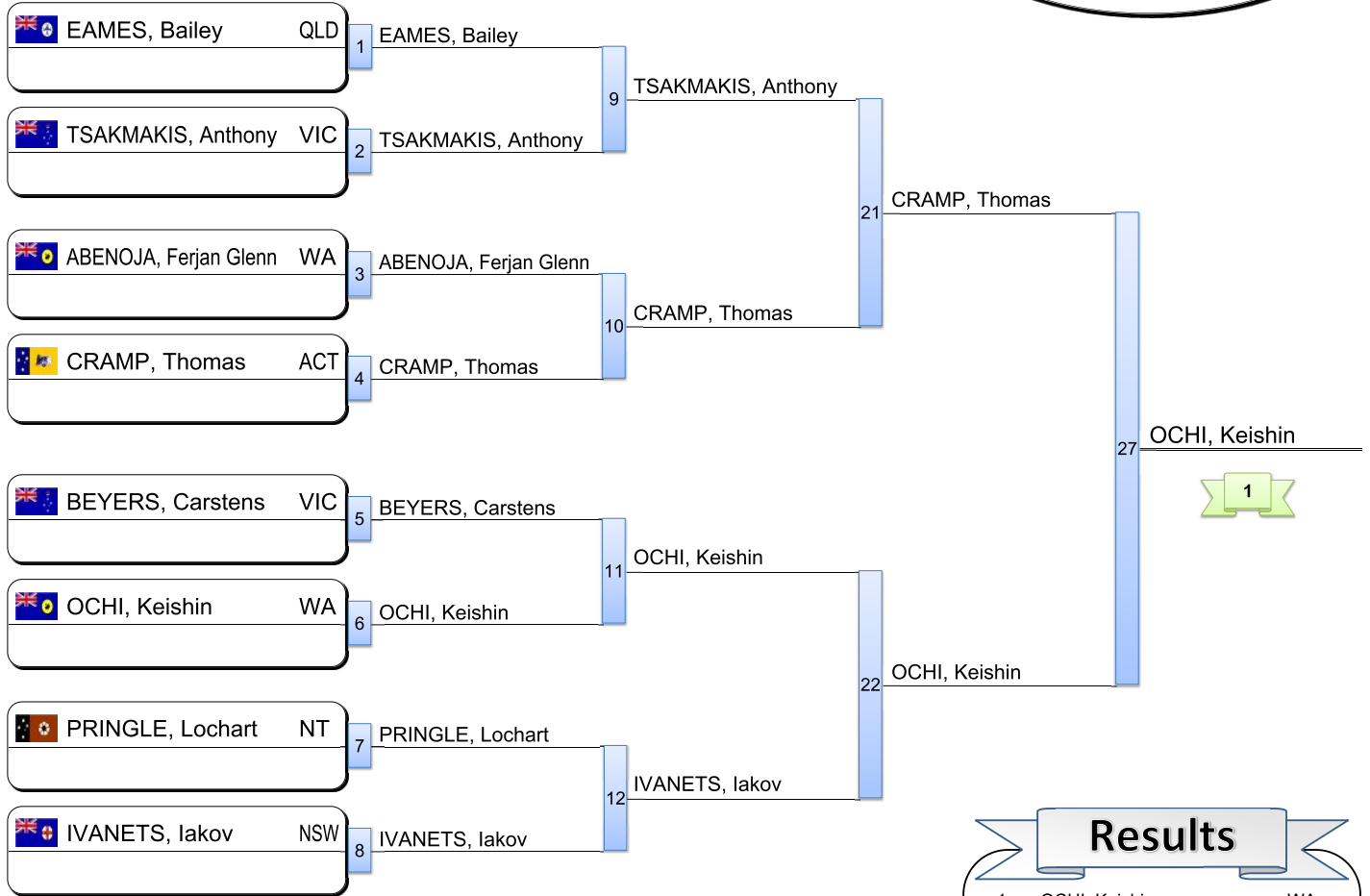

Results

- | | | |
|----|-----------------------|-----|
| 1. | OCHI, Keishin | WA |
| 2. | CRAMP, Thomas | ACT |
| 3. | EAMES, Bailey | QLD |
| 3. | BEYERS, Carstens | VIC |
| 5. | IVANETS, Iakov | NSW |
| 5. | TSAKMAKIS, Anthony | VIC |
| 7. | ABENOJA, Ferjan Glenn | WA |
| 7. | PRINGLE, Lochart | NT |

Repechage

Loser contest **x** will appear at **x** in repechage

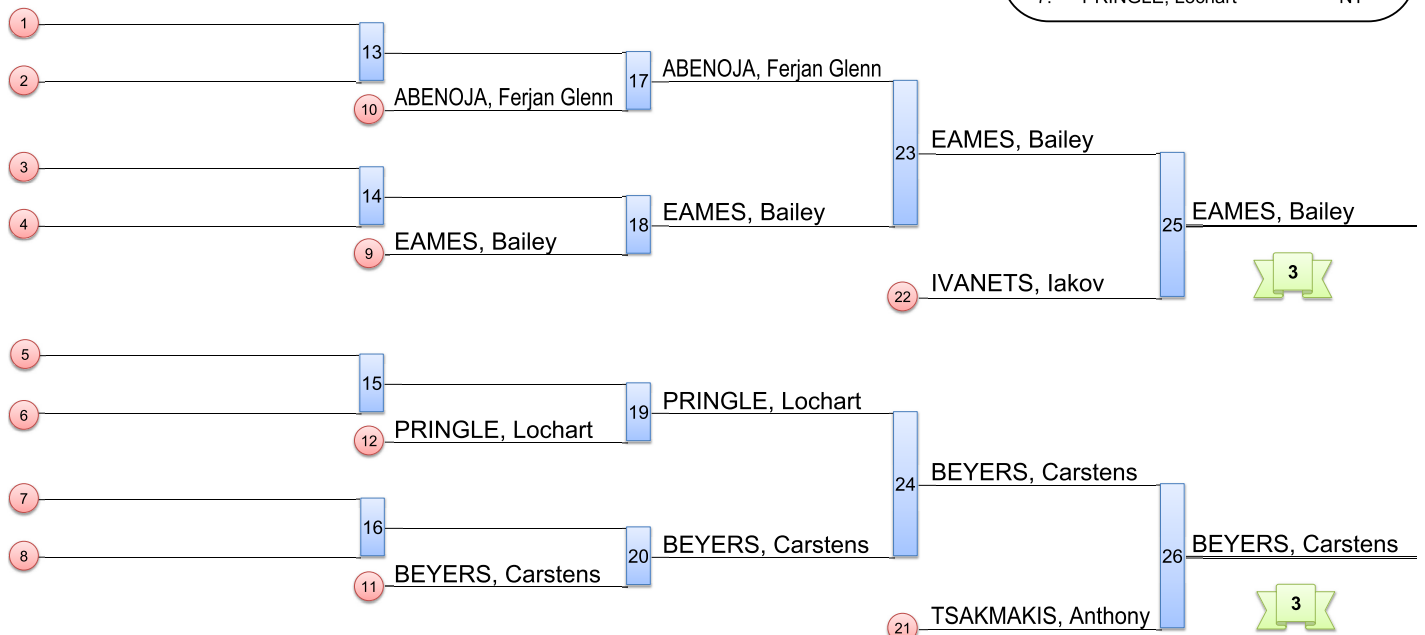

2019 Australian National Championships

Carrara (AUS), 08 Jun 2019

-66 kg

7 Judoka

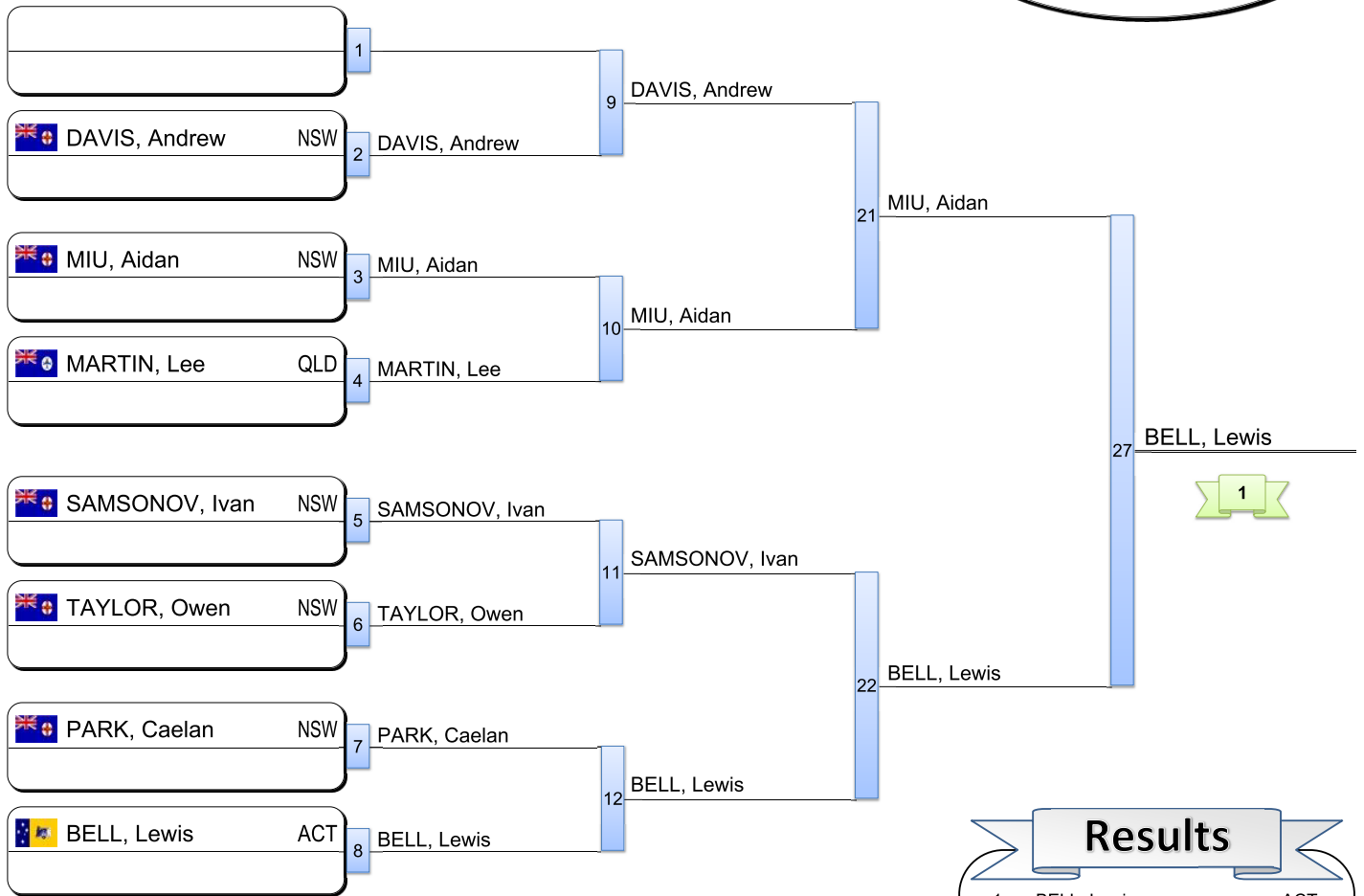

Results

- | | | |
|----|----------------|-----|
| 1. | BELL, Lewis | ACT |
| 2. | MIU, Aidan | NSW |
| 3. | SAMSONOV, Ivan | NSW |
| 3. | DAVIS, Andrew | NSW |
| 5. | MARTIN, Lee | QLD |
| 5. | PARK, Caelan | NSW |
| 7. | | |
| 7. | TAYLOR, Owen | NSW |

Repechage

Loser contest will appear at in repechage

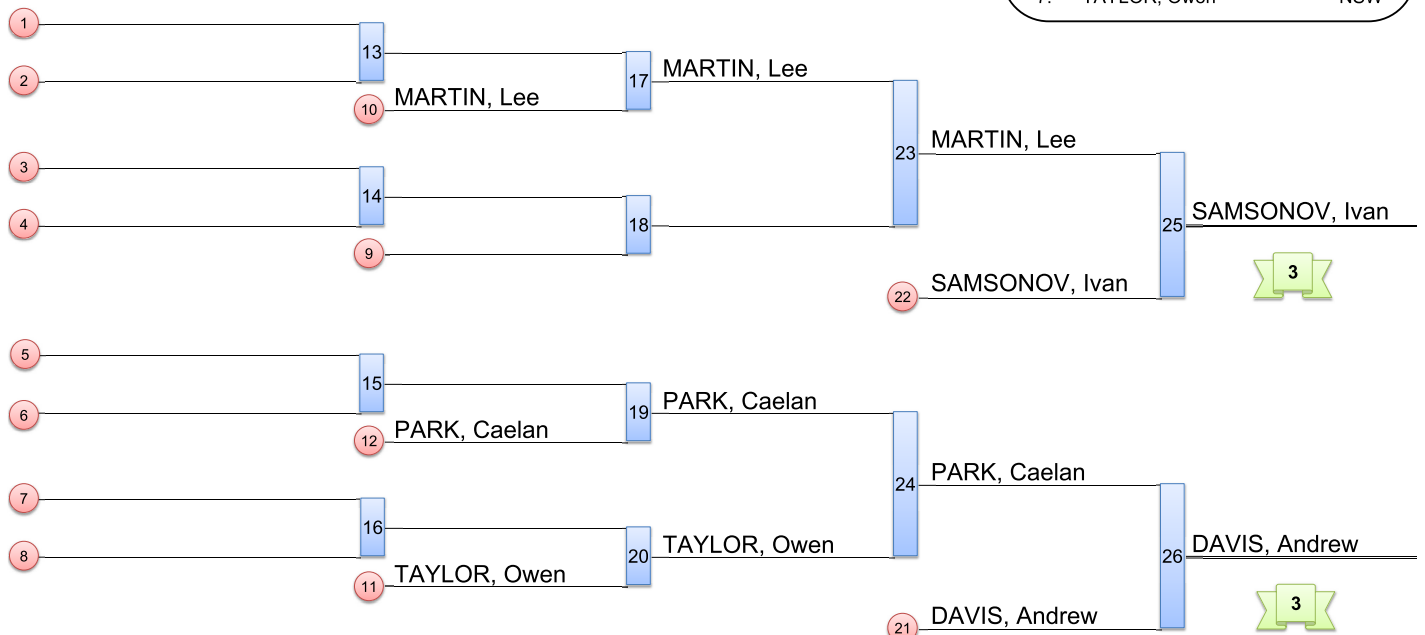

2019 Australian National Championships

Carrara (AUS), 08 Jun 2019

+66 kg

9 Judoka

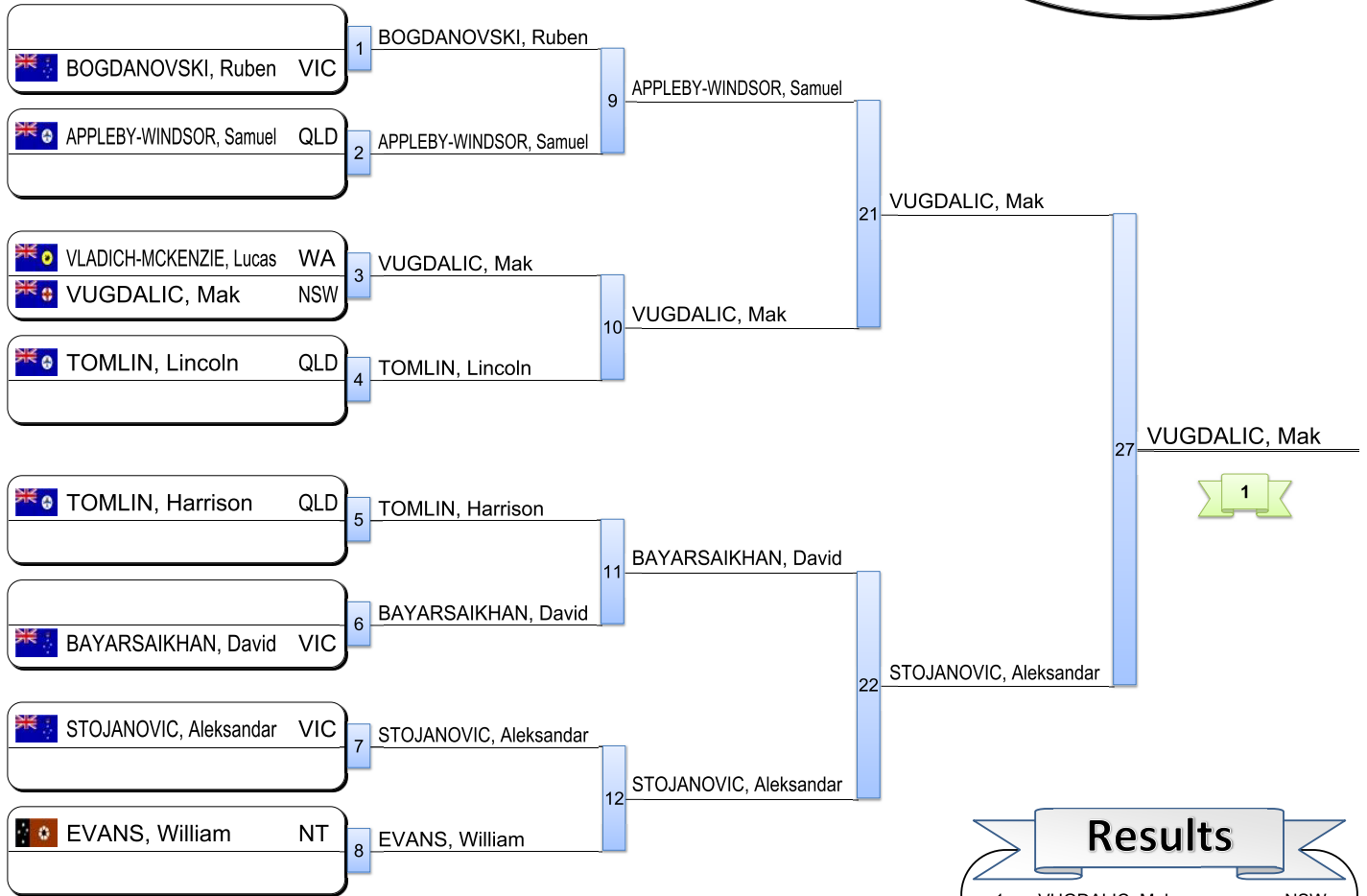

Results

- | | | |
|----|-------------------------|-----|
| 1. | VUGDALIC, Mak | NSW |
| 2. | STOJANOVIC, Aleksandar | VIC |
| 3. | BAYARSAIKHAN, David | VIC |
| 3. | APPLEBY-WINDSOR, Samuel | QLD |
| 5. | TOMLIN, Lincoln | QLD |
| 5. | EVANS, William | NT |
| 7. | BOGDANOVSKI, Ruben | VIC |
| 7. | TOMLIN, Harrison | QLD |

Repechage

Loser contest will appear at in repechage

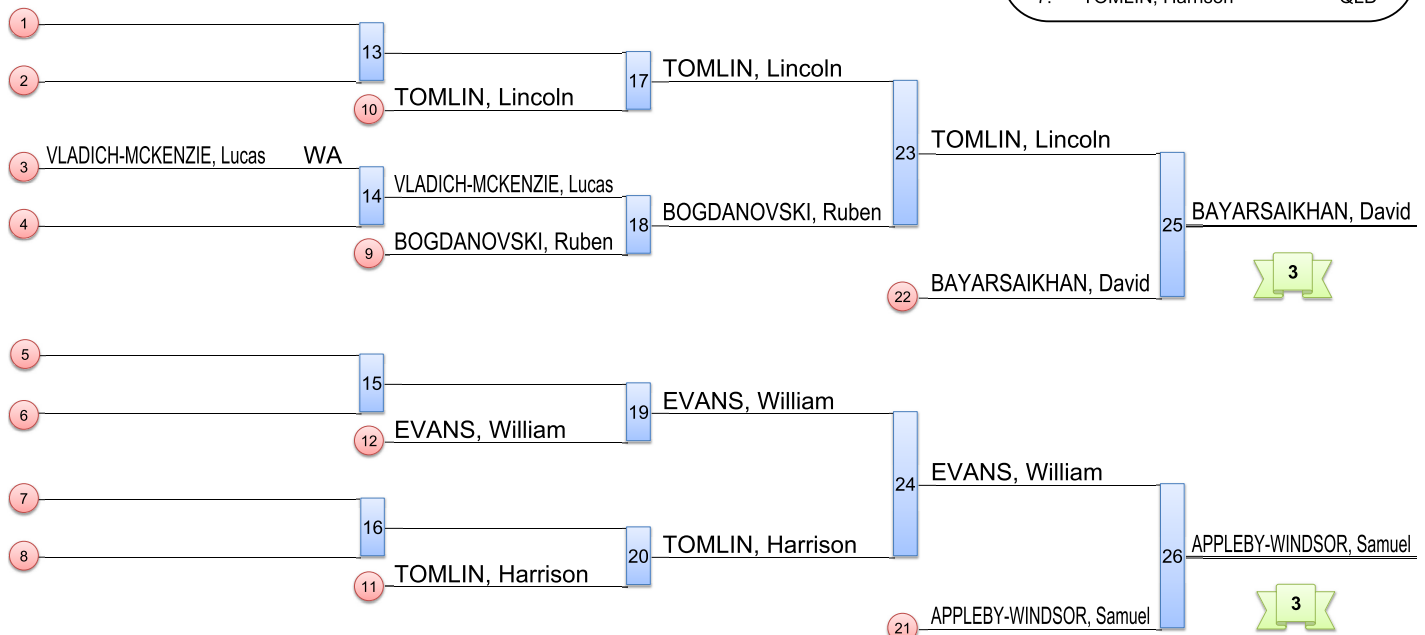

2019 Australian National Championships

Carrara (AUS), 08 Jun 2019

-32G kg

2 Judoka

BEST OF THREE

1	LIAO, Jaeda	NSW	1	TOURNIER, Maelie	WA	00 s2 / 10	2:49
2	TOURNIER, Maelie	WA					

1	LIAO, Jaeda	NSW	2	TOURNIER, Maelie	WA	00 s2 / 10	2:42
2	TOURNIER, Maelie	WA					

1	LIAO, Jaeda	NSW	3				
2	TOURNIER, Maelie	WA					

Final Results

- 1.
- 2.

2019 Australian National Championships

Carrara (AUS), 08 Jun 2019

-36G kg

5 Judoka

			1	3	5	Wins Score	
1	ANDERSON, Nanami	QLD		0	0	0 0	
3	BANNISTER, Callie	QLD	1		1	2 0	
5	HILL, Hannah	ACT	1	0		1 0	

			2	4	Wins	Scores
2	KING, Zoe	QLD		1		(0)
4	BLACK, Jada	QLD	0			(0)

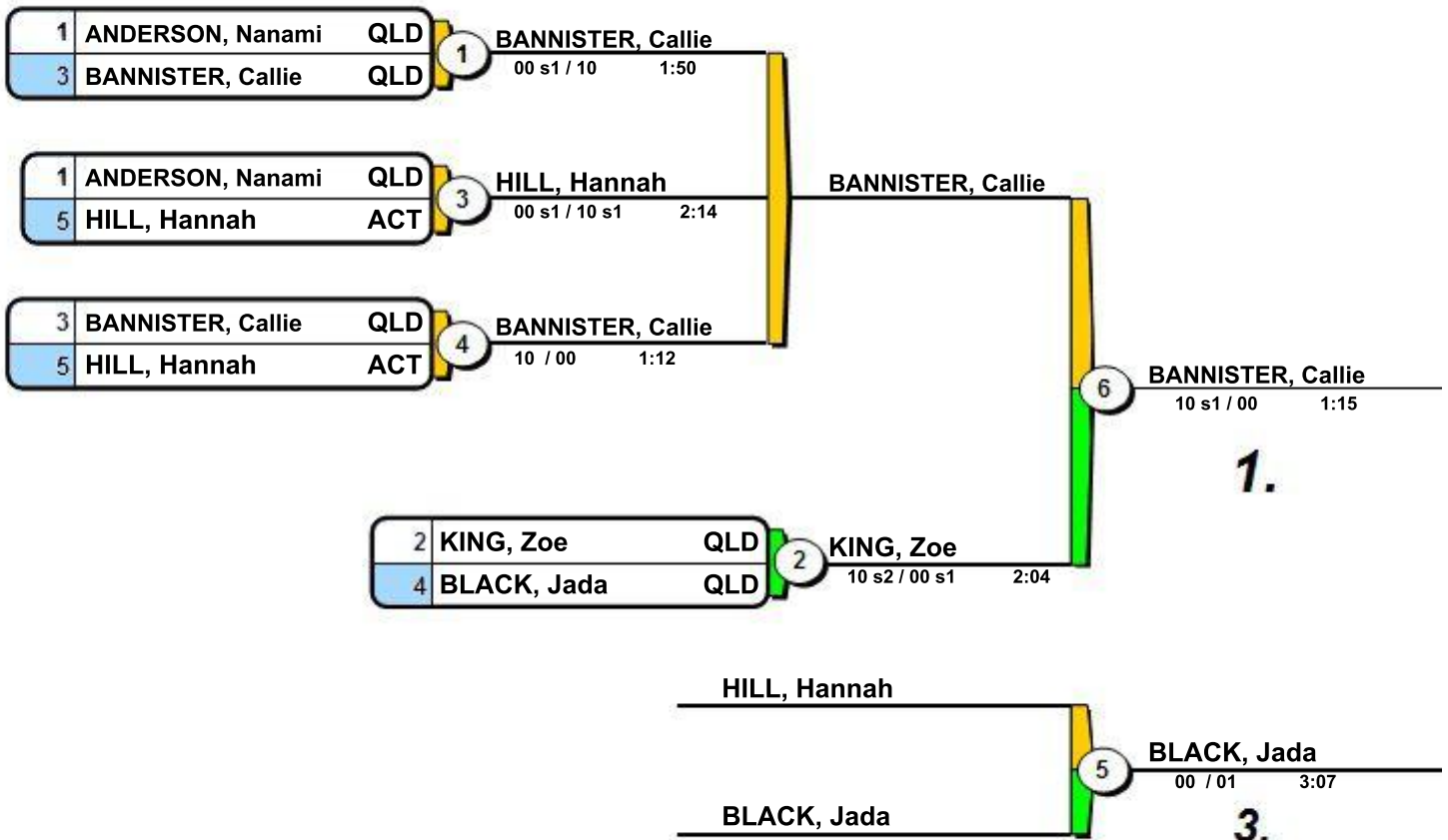

Final Results

1. BANNISTER, Callie QLD
2. KING, Zoe QLD
3. BLACK, Jada QLD

2019 Australian National Championships

Carrara (AUS), 08 Jun 2019

-40G kg

4 Judoka

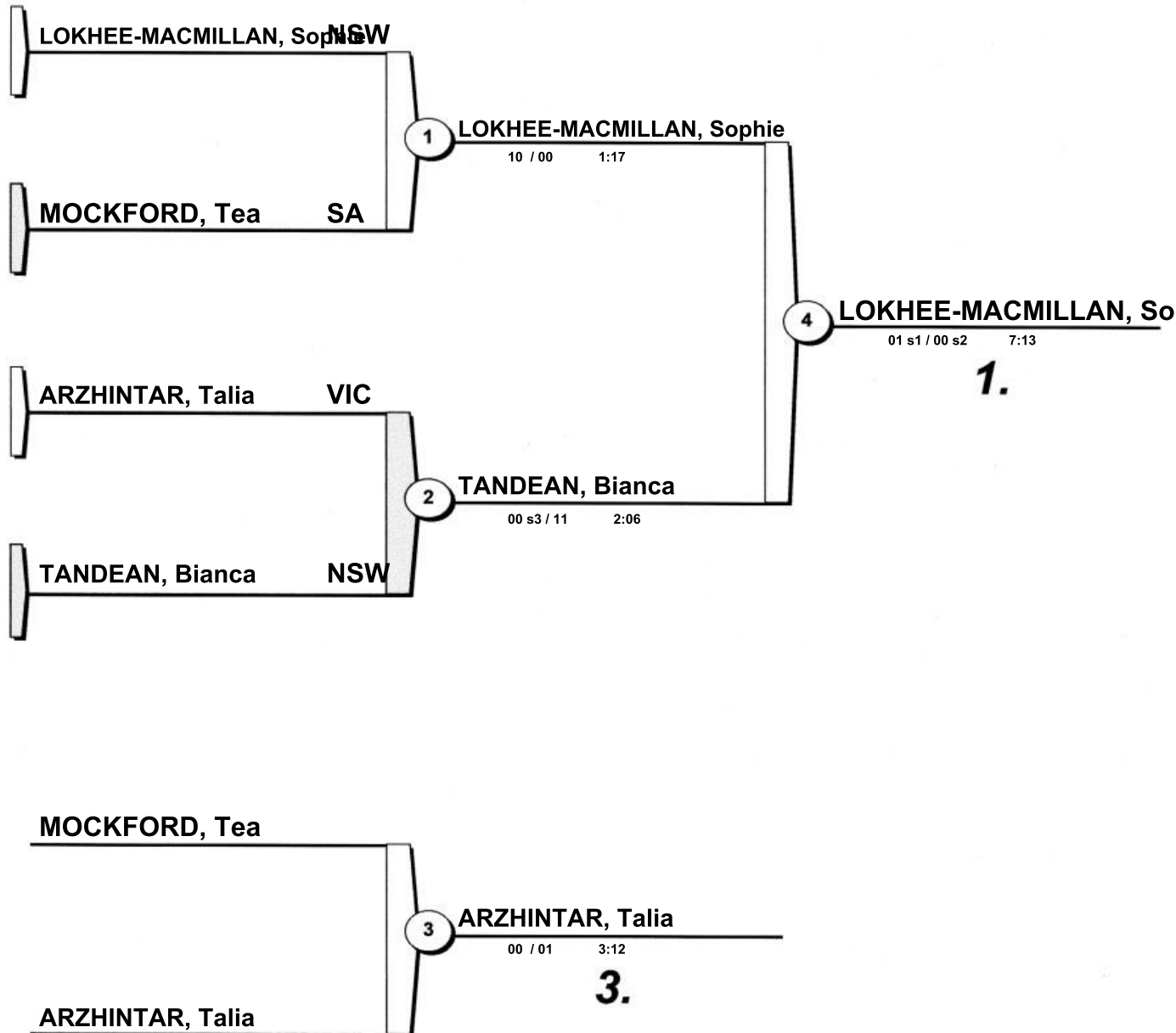

Final Results

1. LOKHEE-MACMILLAN, Sophie **NSW**
2. TANDEAN, Bianca **NSW**
3. ARZHINTAR, Talia **VIC**

2019 Australian National Championships

Carrara (AUS), 08 Jun 2019

-44 kg

9 Judoka

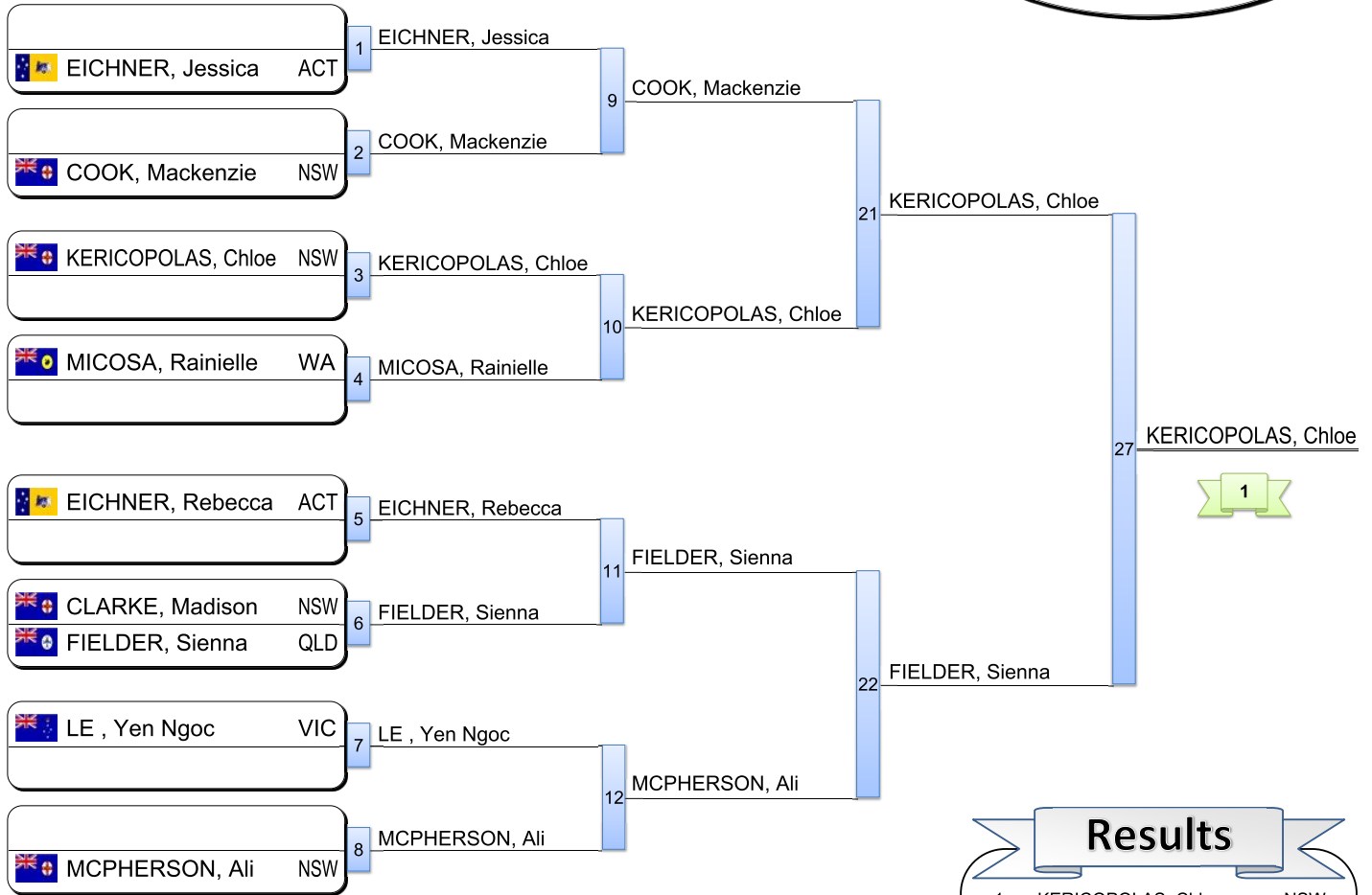

Results		
1.	KERICOPOLOS, Chloe	NSW
2.	FIELDER, Sienna	QLD
3.	MCPHERSON, Ali	NSW
3.	CLARKE, Madison	NSW
5.	MICOSA, Rainielle	WA
5.	COOK, Mackenzie	NSW
7.	EICHNER, Jessica	ACT
7.	EICHNER, Rebecca	ACT

Repechage

Loser contest x will appear at x in repechage

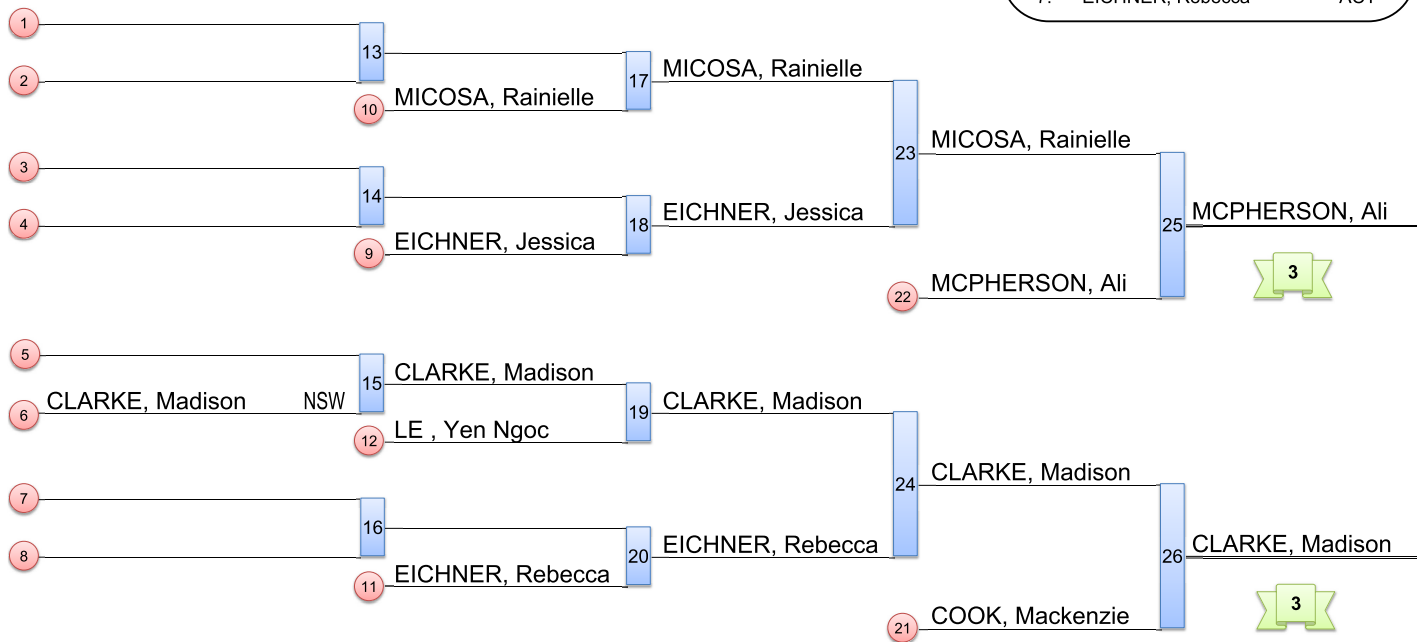

2019 Australian National Championships

Carrara (AUS), 08 Jun 2019

-48 kg

10 Judoka

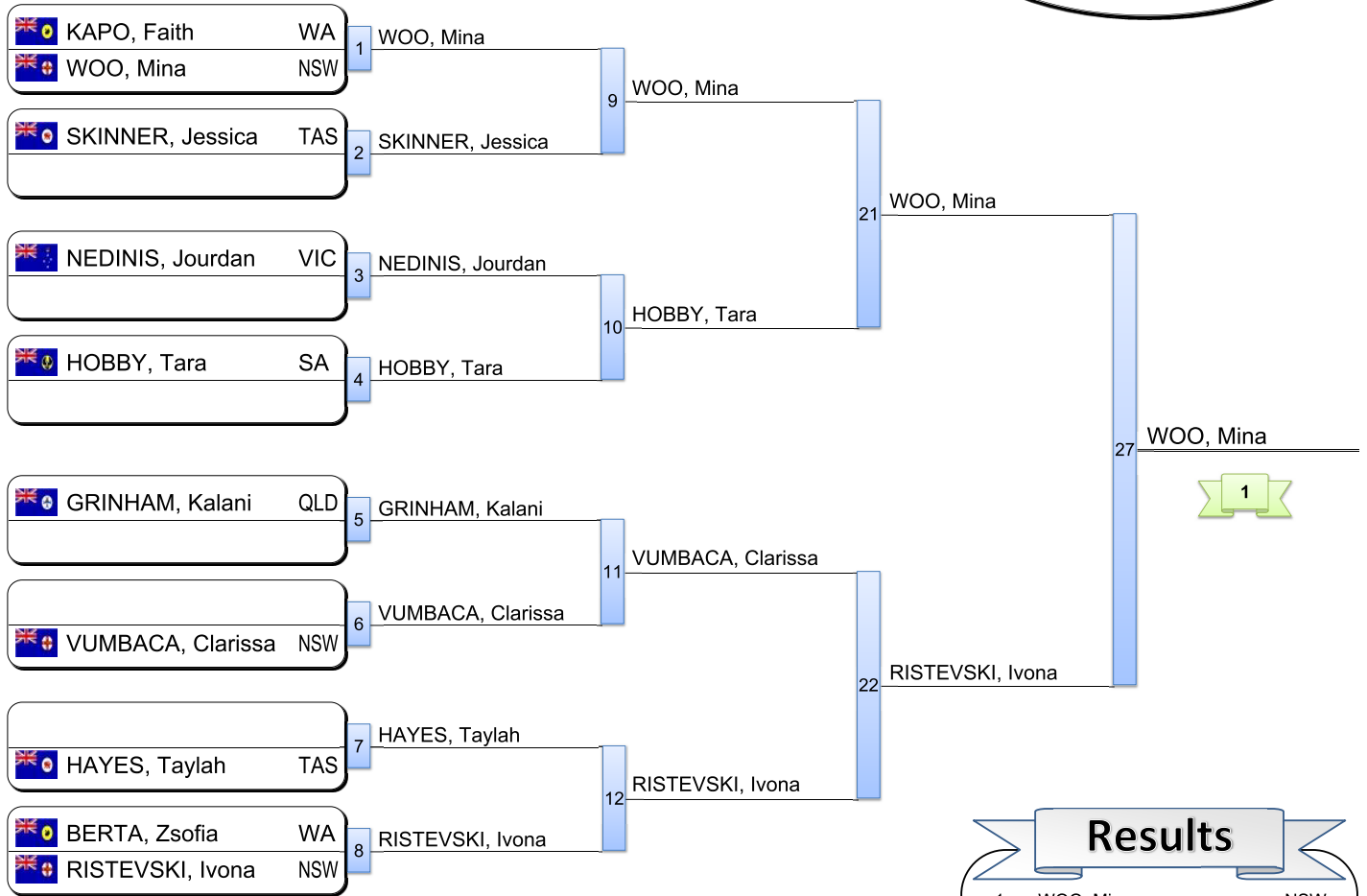

Repechage

Loser contest will appear at in repechage

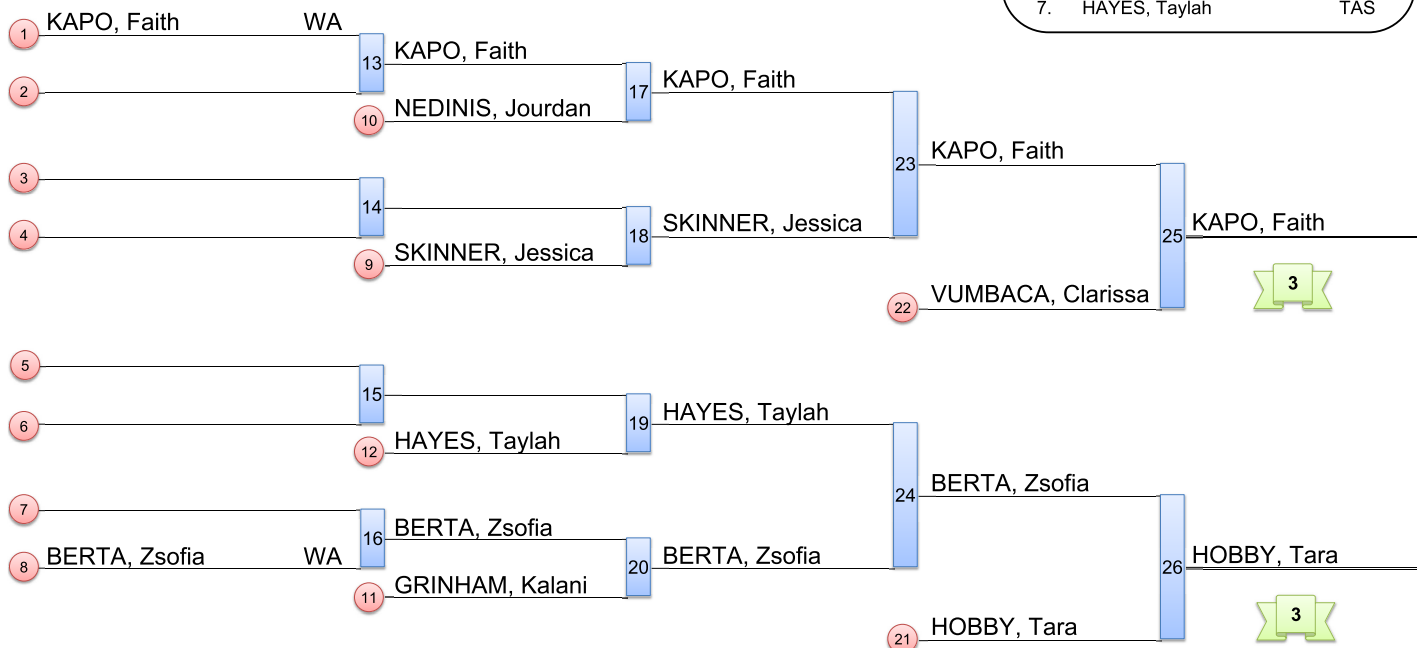

2019 Australian National Championships

Carrara (AUS), 08 Jun 2019

-52 kg

8 Judoka

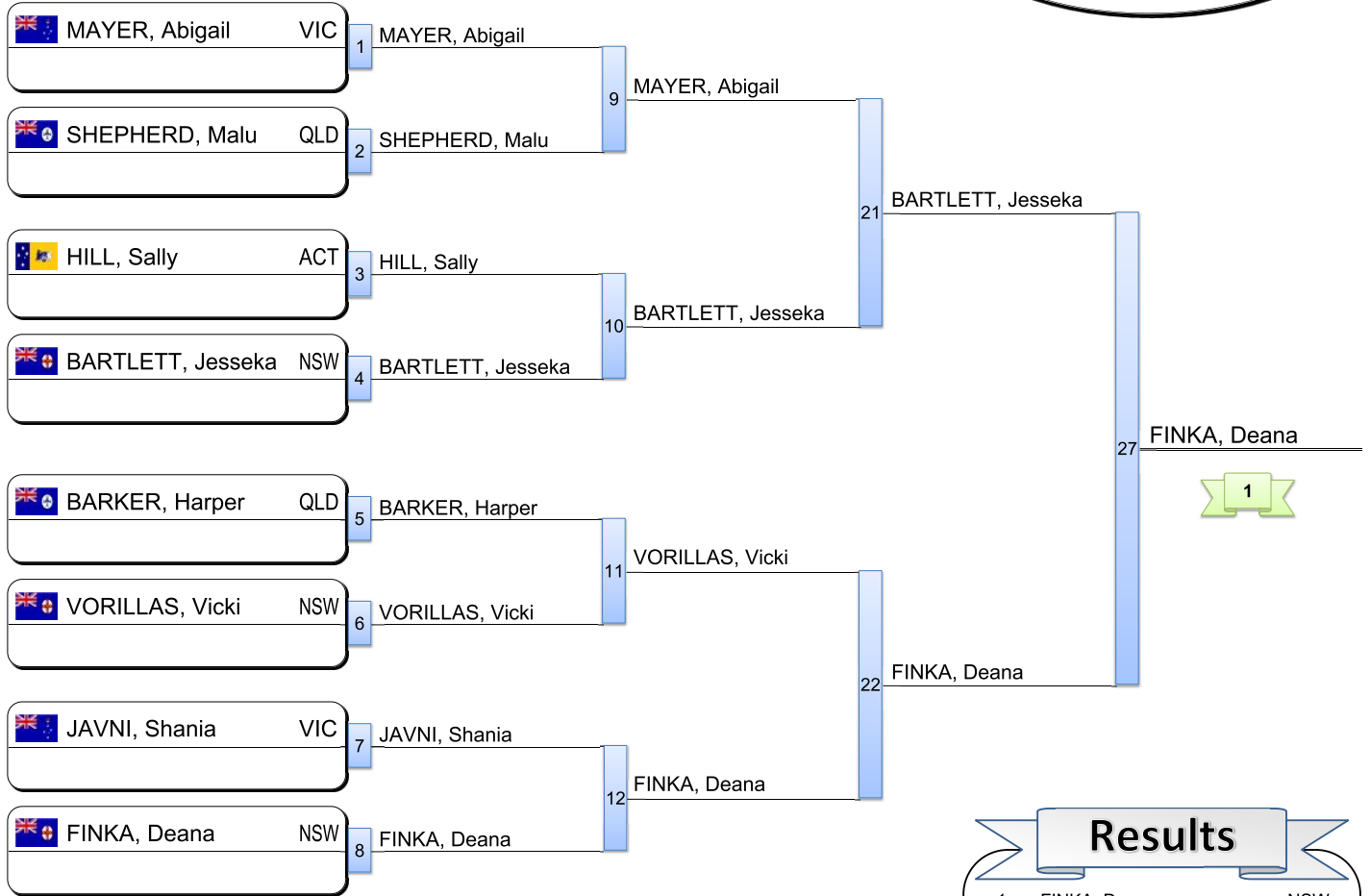

Results

1. FINKA, Deana NSW
2. BARTLETT, Jesseka NSW
3. HILL, Sally ACT
3. MAYER, Abigail VIC
5. VORILLAS, Vicki NSW
5. JAVNI, Shania VIC
7. SHEPHERD, Malu QLD
7. BARKER, Harper QLD

Repechage

Loser contest **x** will appear at **x** in repechage

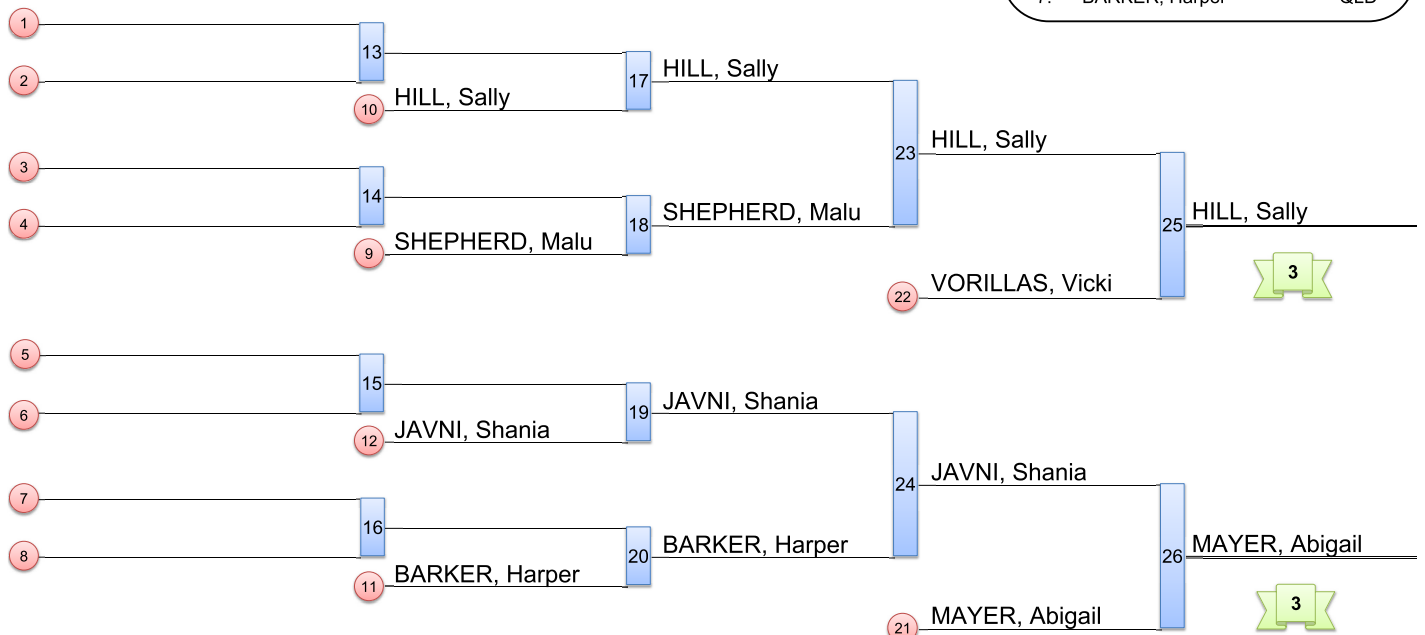

2019 Australian National Championships

Carrara (AUS), 08 Jun 2019

-57 kg

10 Judoka

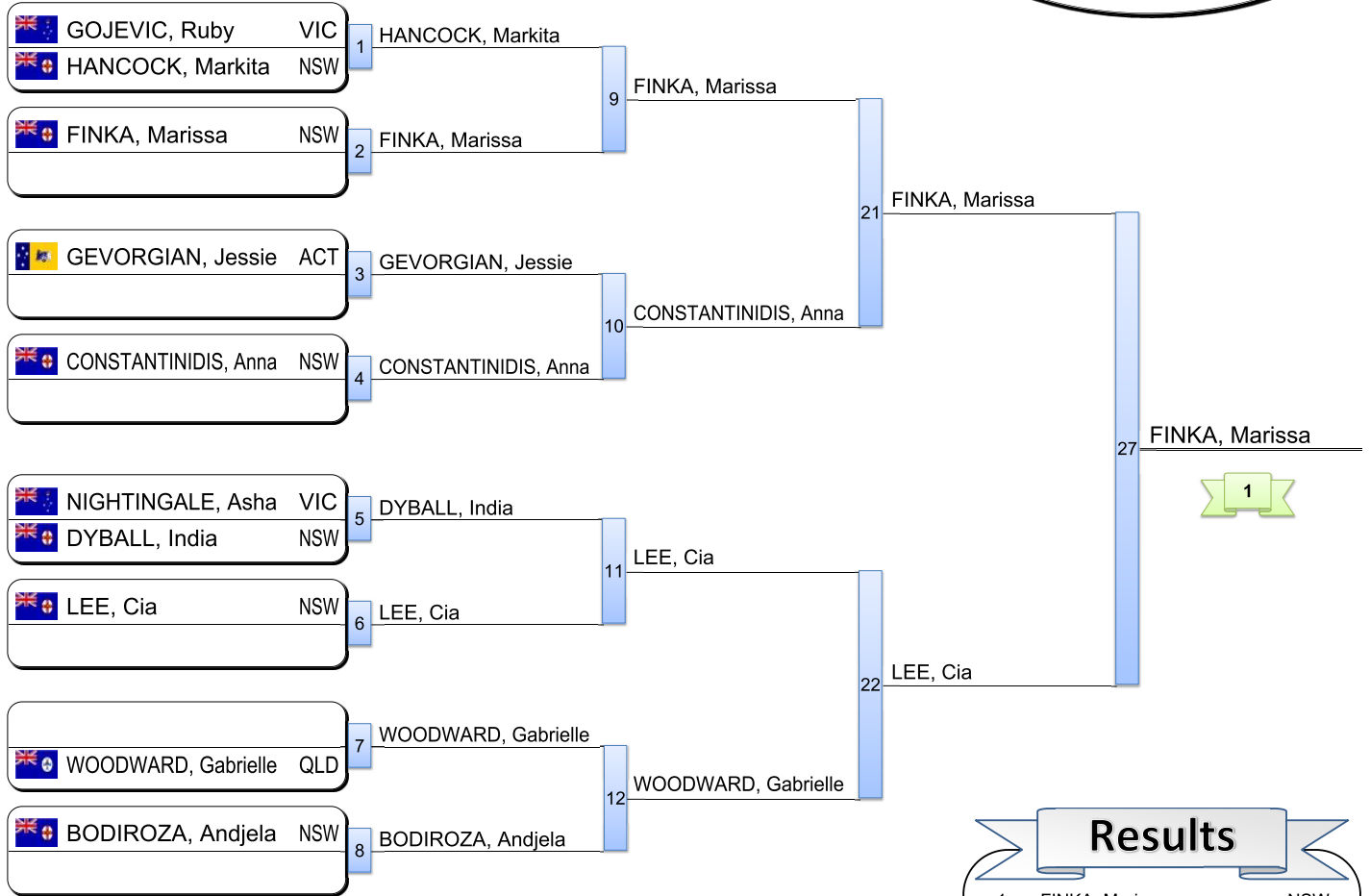

Results

1.	FINKA, Marissa	NSW
2.	LEE, Cia	NSW
3.	WOODWARD, Gabrielle	QLD
3.	DYBALL, India	NSW
5.	HANCOCK, Markita	NSW
5.	CONSTANTINIDIS, Anna	NSW
7.	GEVORGIAN, Jessie	ACT
7.	NIGHTINGALE, Asha	VIC

Repechage

Loser contest **x** will appear at **x** in repechage

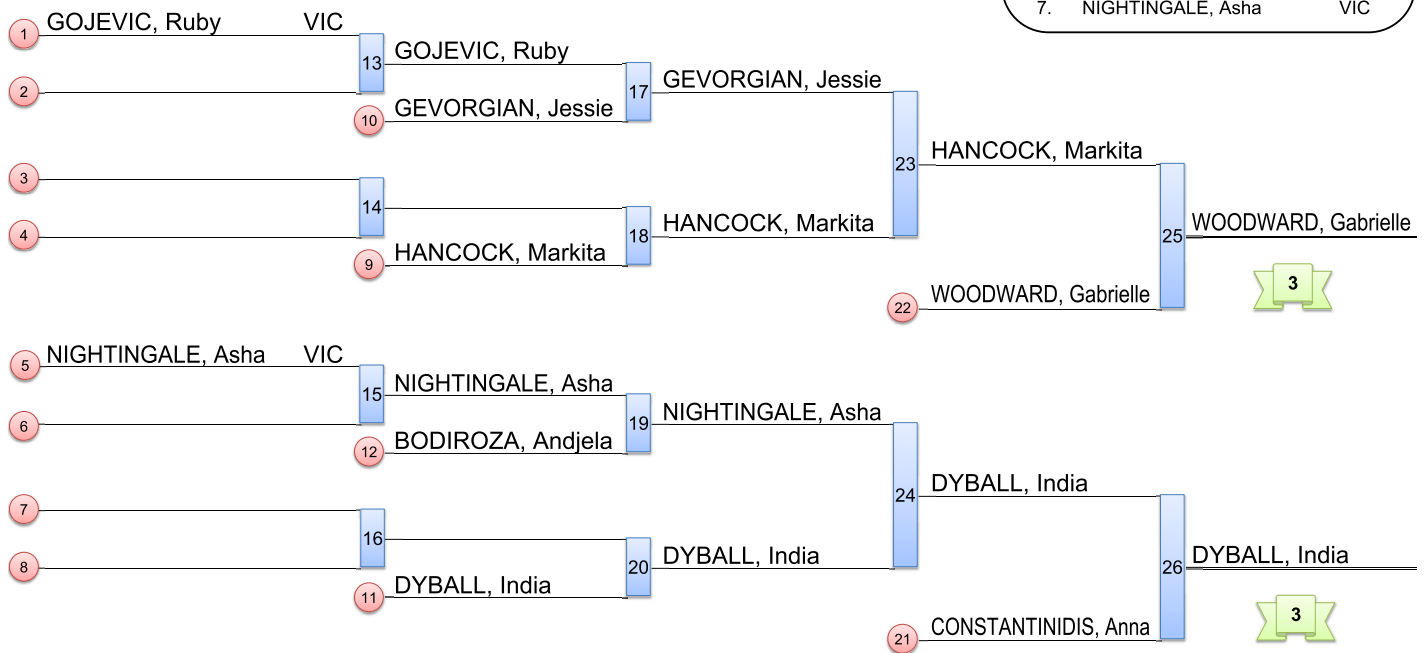

2019 Australian National Championships

Carrara (AUS), 08 Jun 2019

-63 kg

5 Judoka

	1	3	5	Wins Score	
1 ANSKEY, Annika VIC		1	1	2 0	
3 PARFITT, Amelie VIC	0		0	0 0	
5 CHARLES, Ashlee QLD	0	1		1 0	

	2	4	Wins	Scores
2 SAZDOV, Mia VIC		1		(0)
4 MCDONALD, Nikita QLD	0			(0)

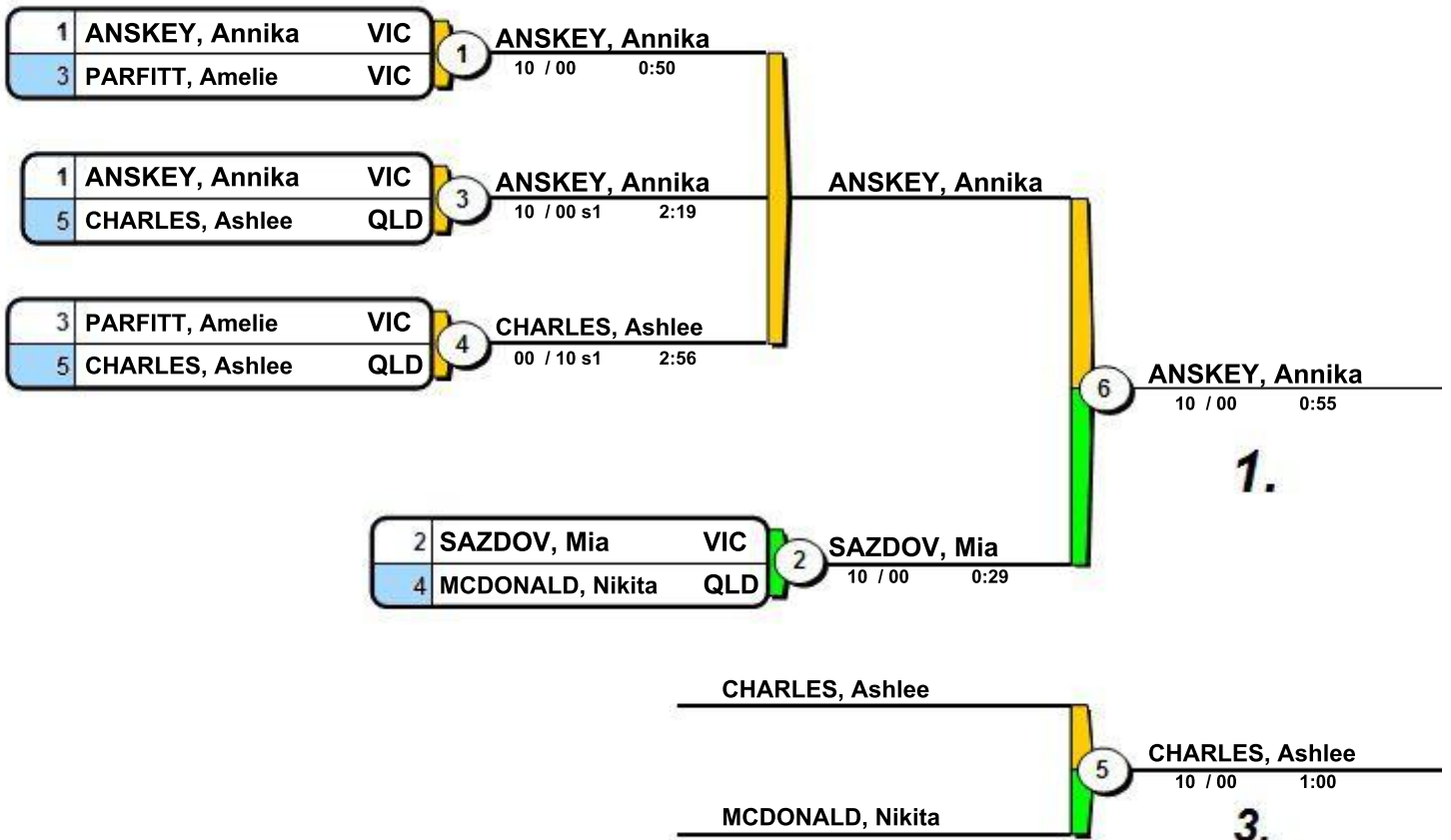

Final Results

1. ANSKEY, Annika VIC
2. SAZDOV, Mia VIC
3. CHARLES, Ashlee QLD

2019 Australian National Championships

Cararra (AUS), 08 Jun 2019

-30 kg

13 Judoka

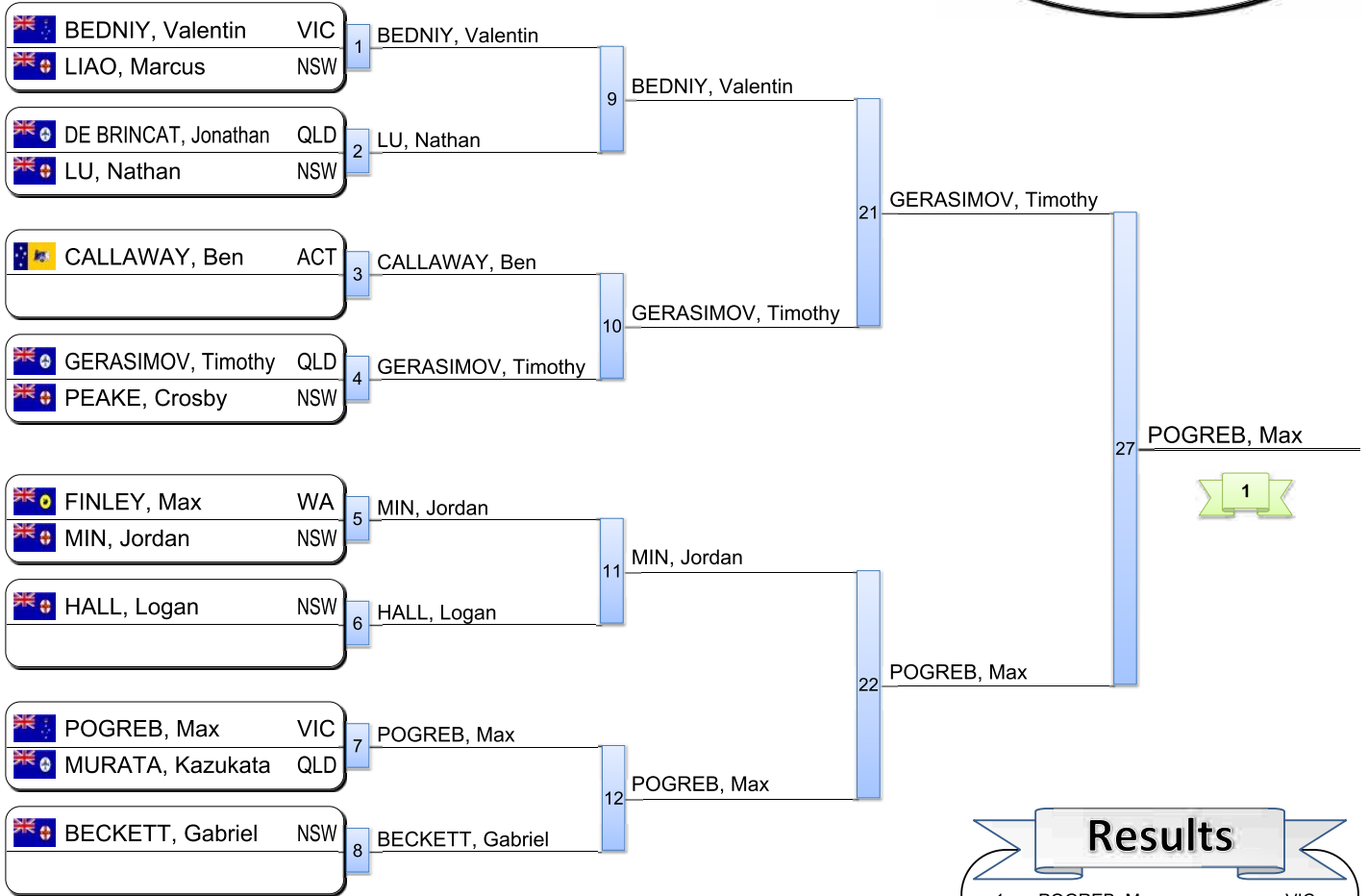

Repechage

Loser contest will appear at in repechage

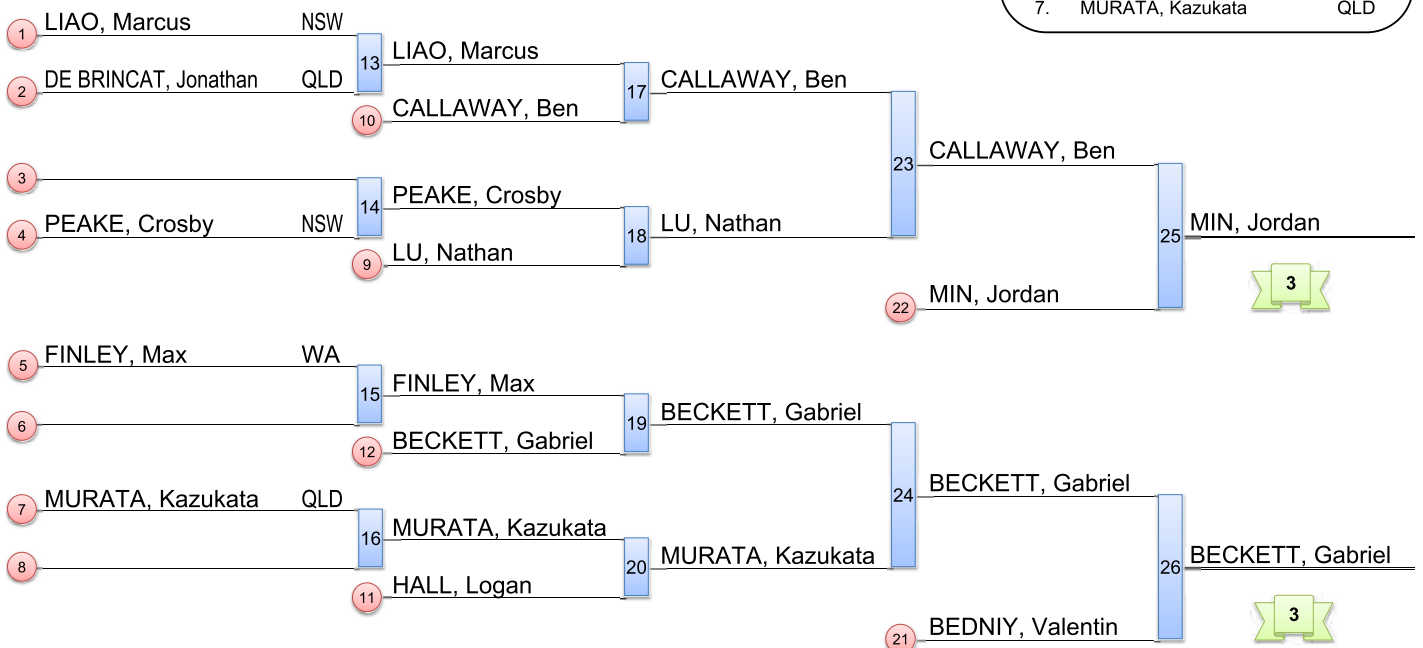

2019 Australian National Championships

Cararra (AUS), 08 Jun 2019

-34 kg

20 Judoka

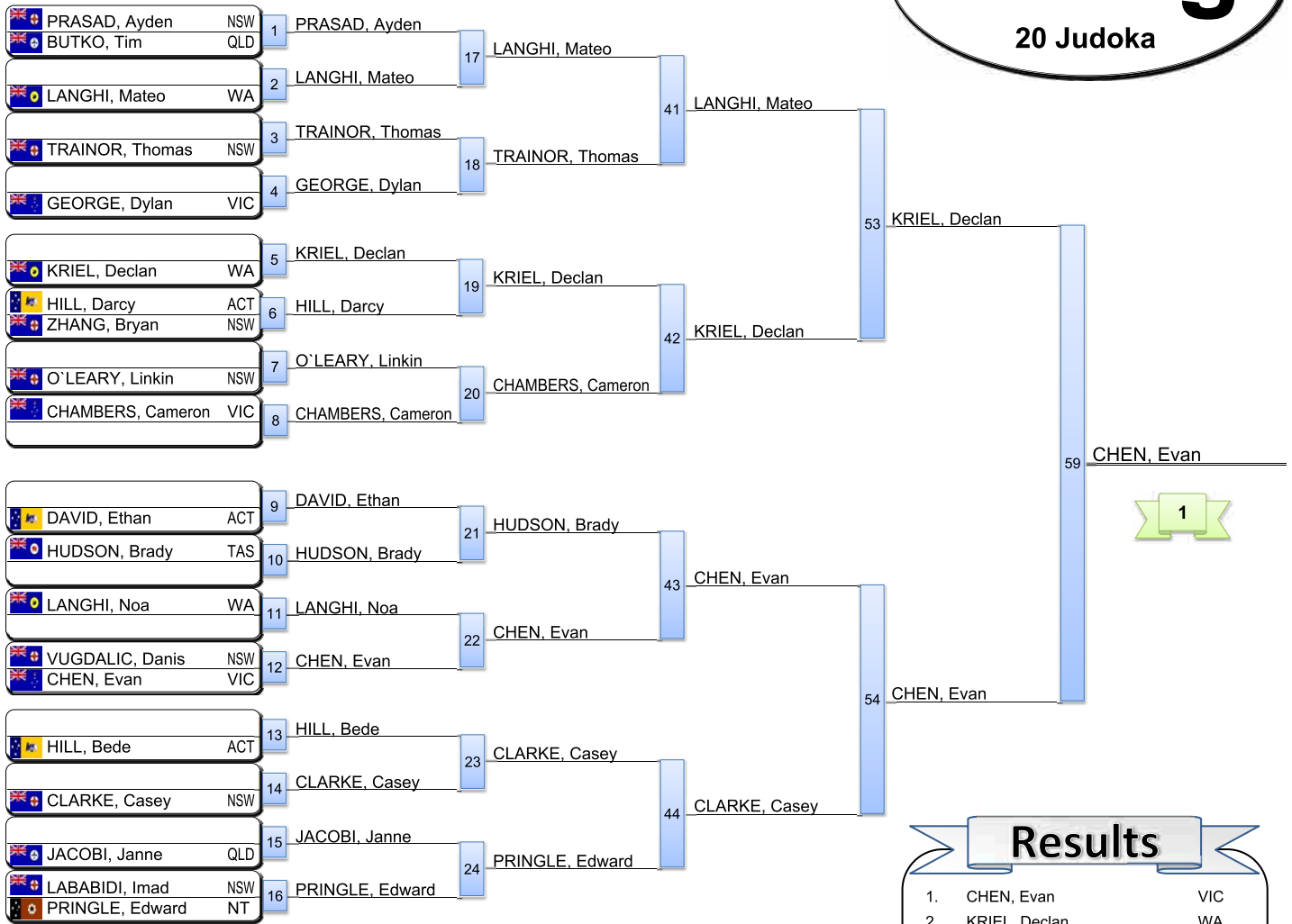

Results

1. CHEN, Evan (VIC)
2. KRIEL, Declan (WA)
3. CLARKE, Casey (NSW)
3. JACOBI, Janne (QLD)
5. TRAINOR, Thomas (NSW)
5. LANGHI, Mateo (WA)
7. GEORGE, Dylan (VIC)
7. PRINGLE, Edward (NT)

Repechage

Loser contest will appear at in repechage

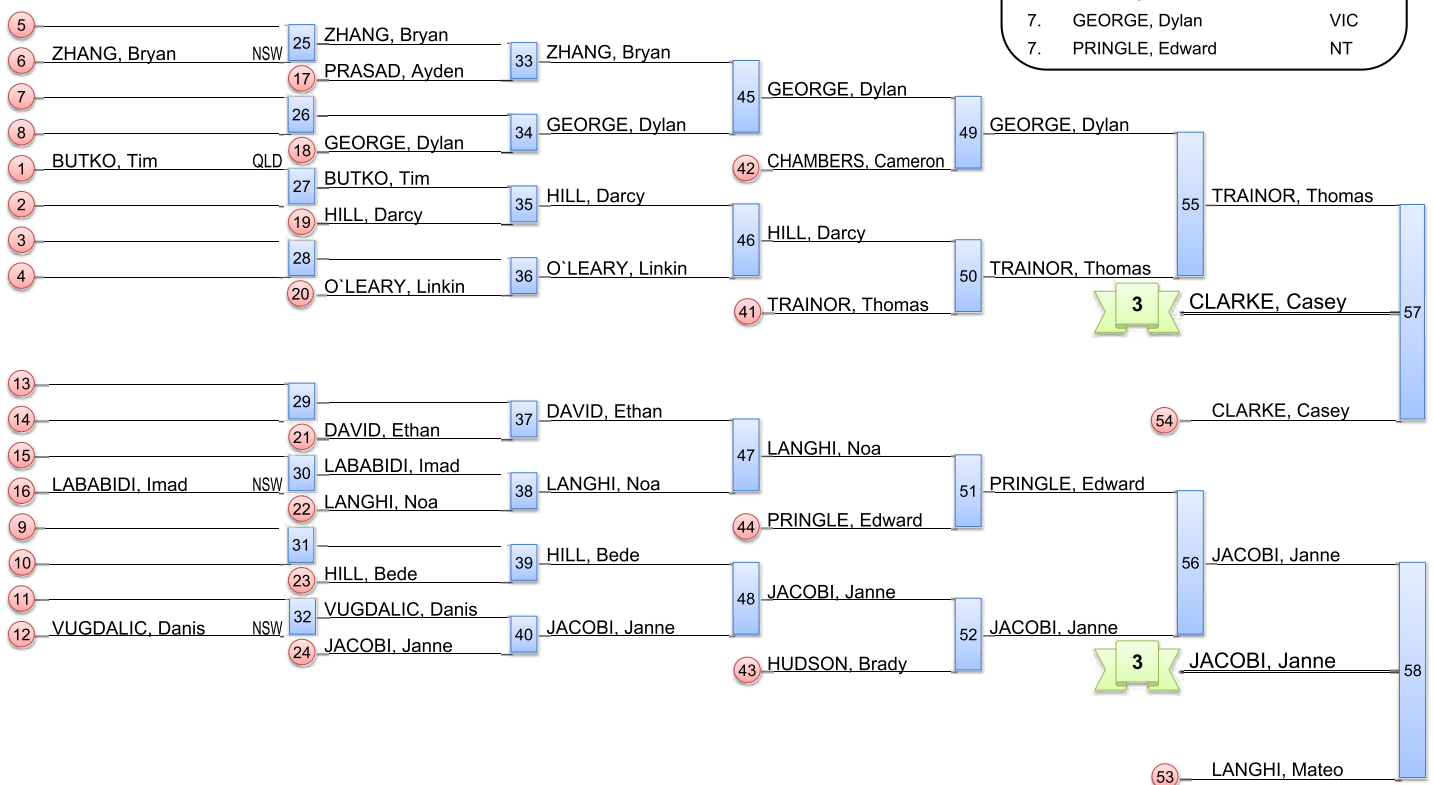

2019 Australian National Championships

Cararra (AUS), 08 Jun 2019

-38 kg

16 Judoka

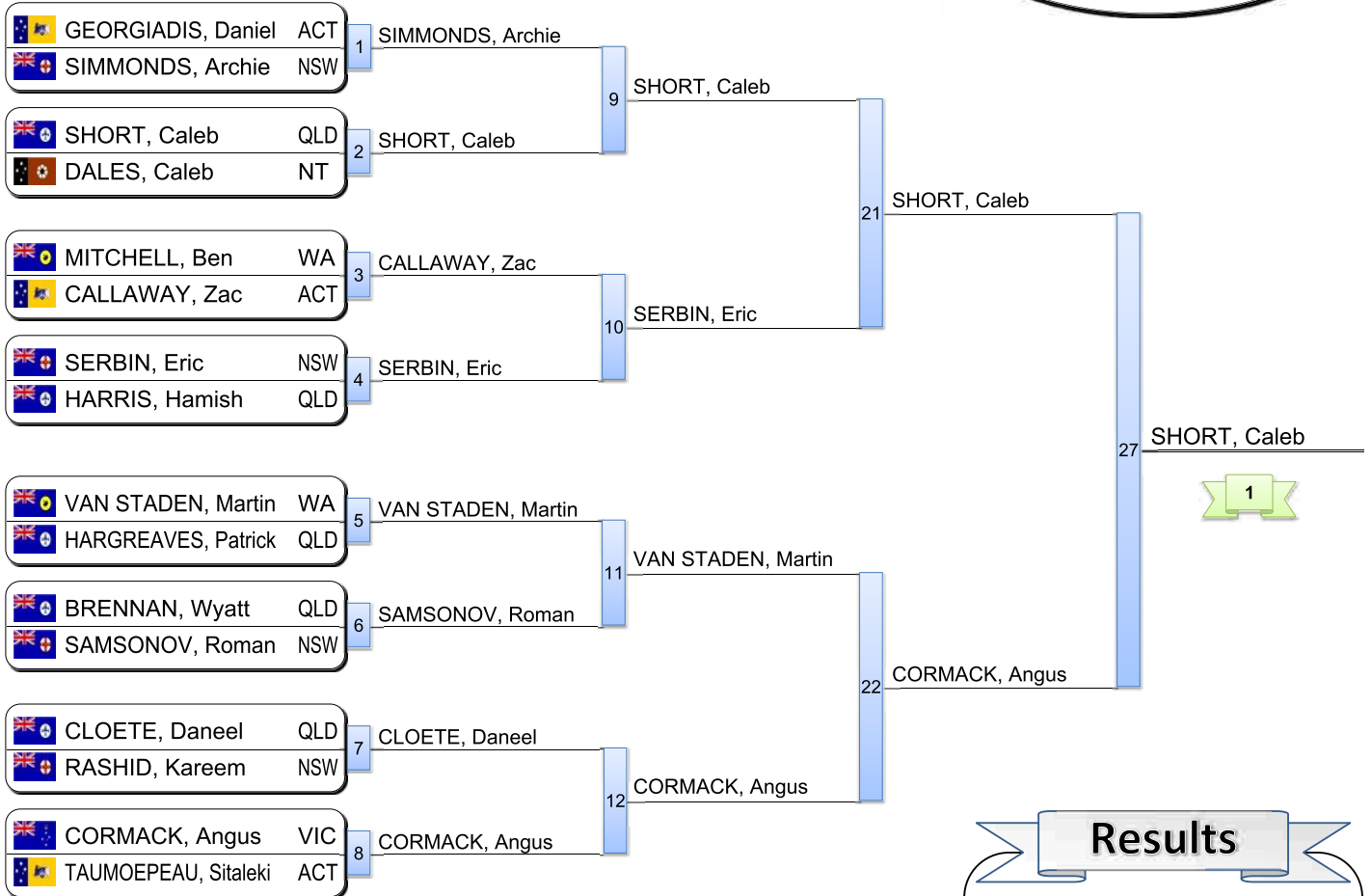

Repechage

Loser contest will appear at in repechage

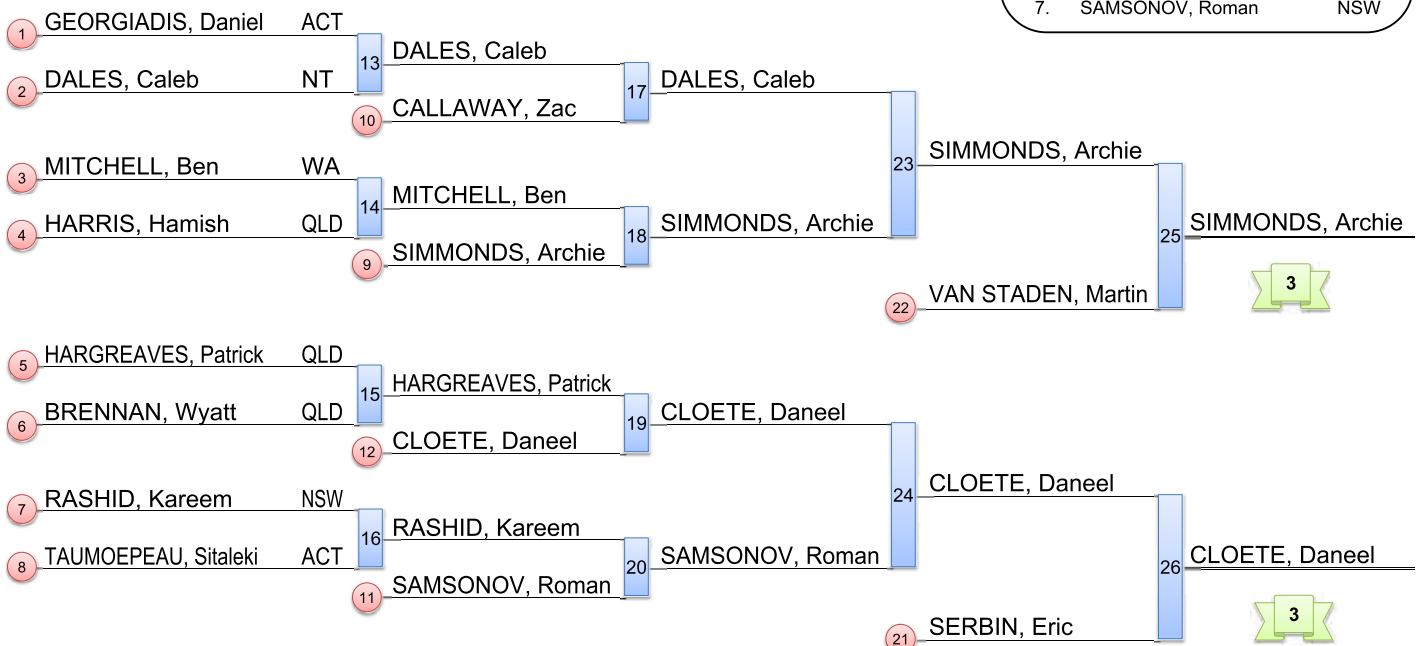

2019 Australian National Championships

Cararra (AUS), 08 Jun 2019

-42 kg

6 Judoka

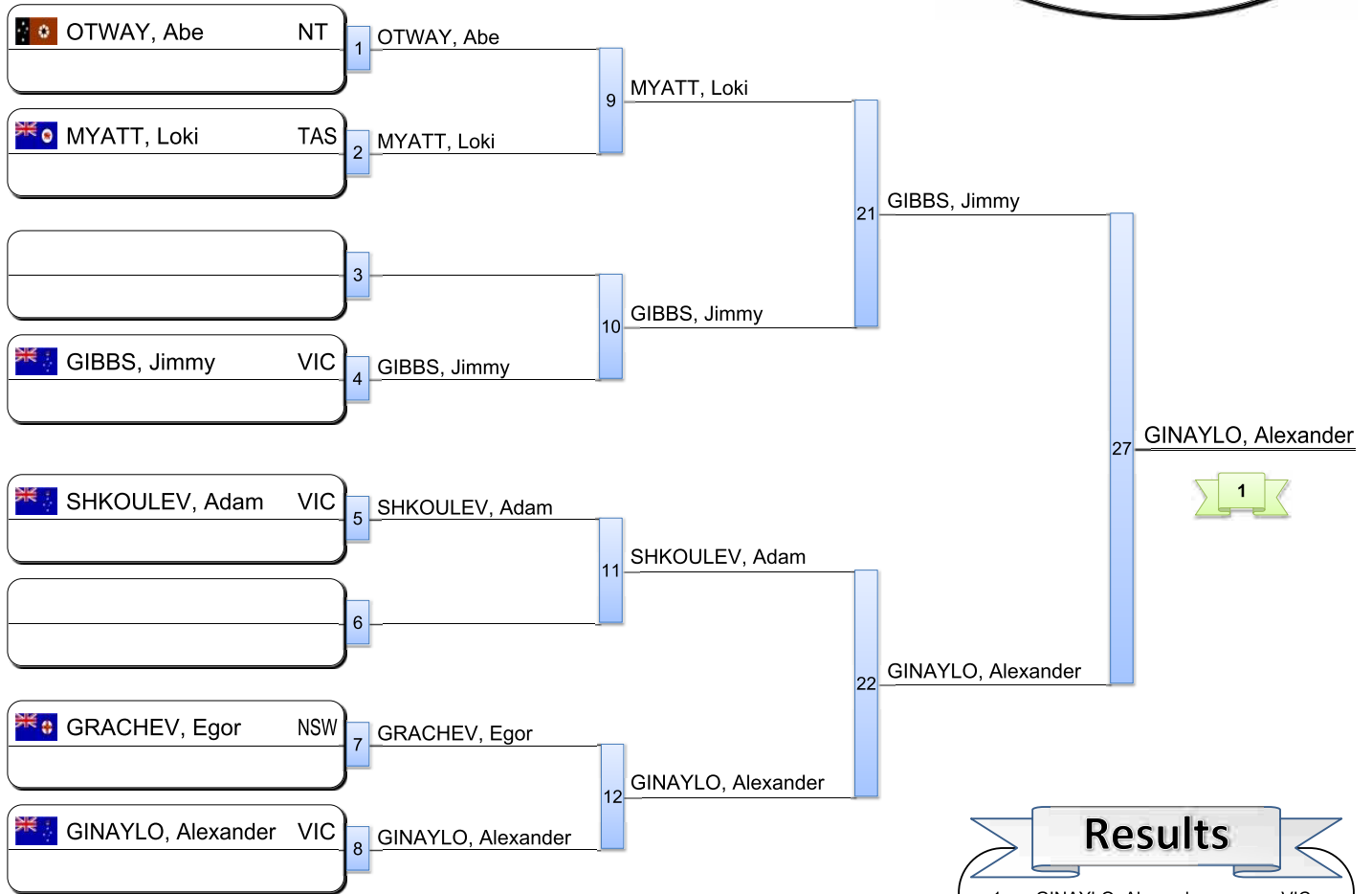

Results

1. GINAYLO, Alexander VIC
2. GIBBS, Jimmy VIC
3. SHKOULEV, Adam VIC
3. GRACHEV, Egor NSW
5. OTWAY, Abe NT
5. MYATT, Loki TAS
- 7.
- 7.

Repechage

Loser contest will appear at in repechage

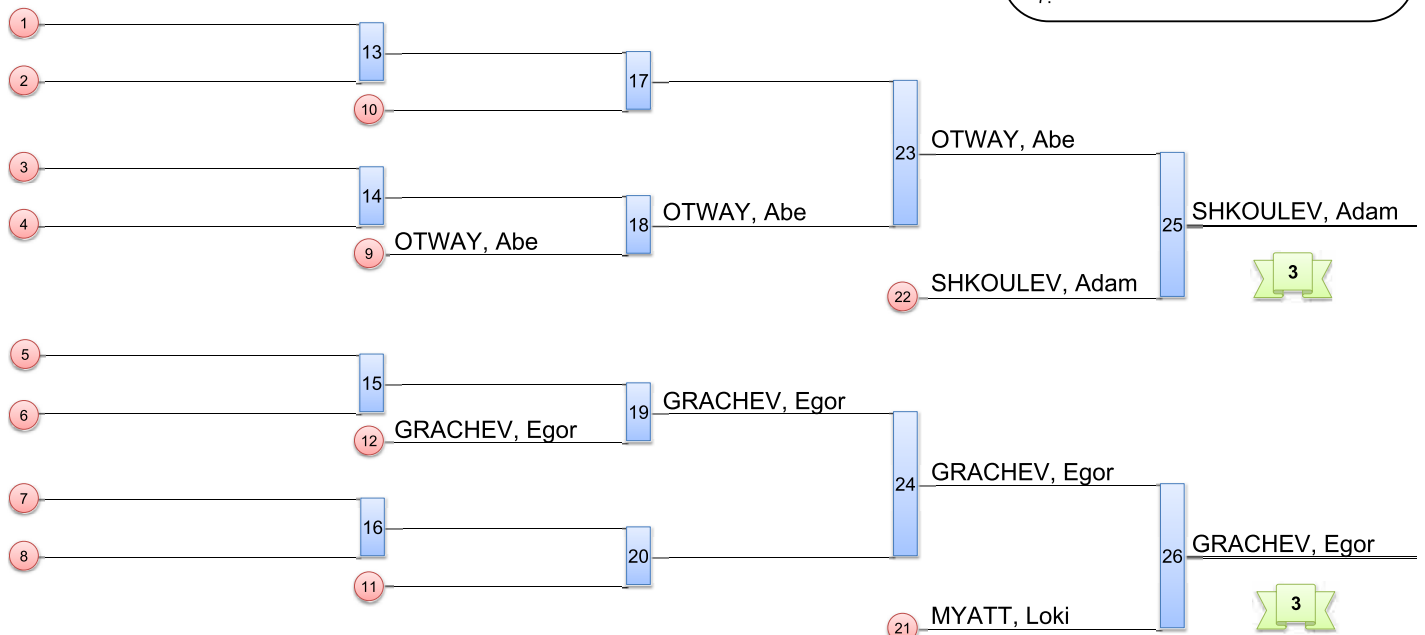

2019 Australian National Championships

Cararra (AUS), 08 Jun 2019

-46 kg

5 Judoka

	1	3	5	Wins Score	
1 SCHMIDT, Max QLD		0	0	0 0	
3 SFREGOLA, Giuseppe VIC	1		1	2 0	
5 VAN DER MERWE, Rudolf (Rj)WA	1	0		1 0	

	2	4	Wins	Scores
2 BURNS, Asahi ACT		0		(0)
4 TOPP, Kai QLD	1			(0)

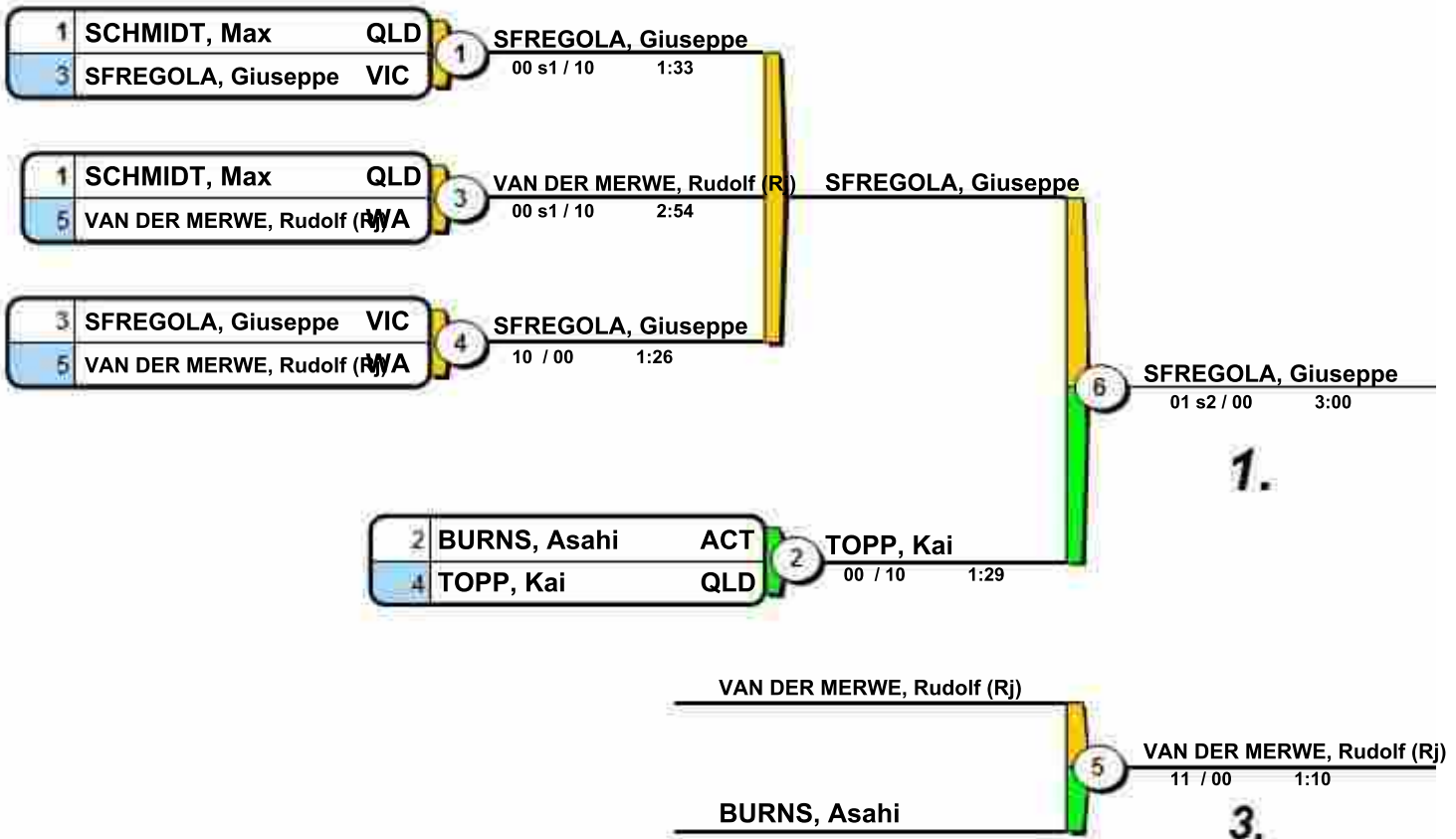

Final Results

1. SFREGOLA, Giuseppe VIC
2. TOPP, Kai QLD
3. VAN DER MERWE, Rudolf (Rj)WA

2019 Australian National Championships

Cararra (AUS), 08 Jun 2019

-50 kg

4 Judoka

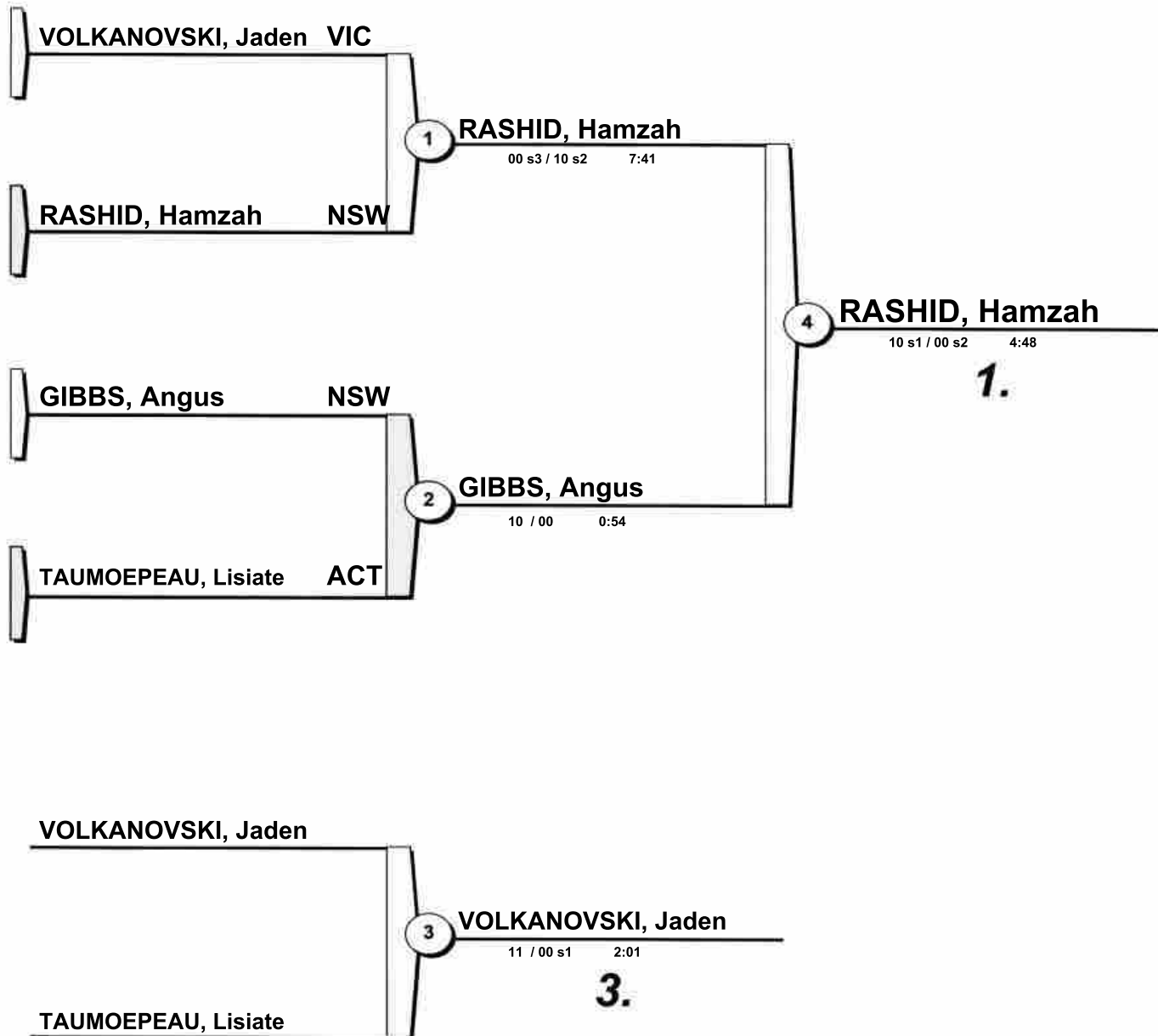

Final Results

1. RASHID, Hamzah NSW
2. GIBBS, Angus NSW
3. VOLKANOVSKI, Jaden VIC

2019 Australian National Championships

Cararra (AUS), 08 Jun 2019

+50 kg

4 Judoka

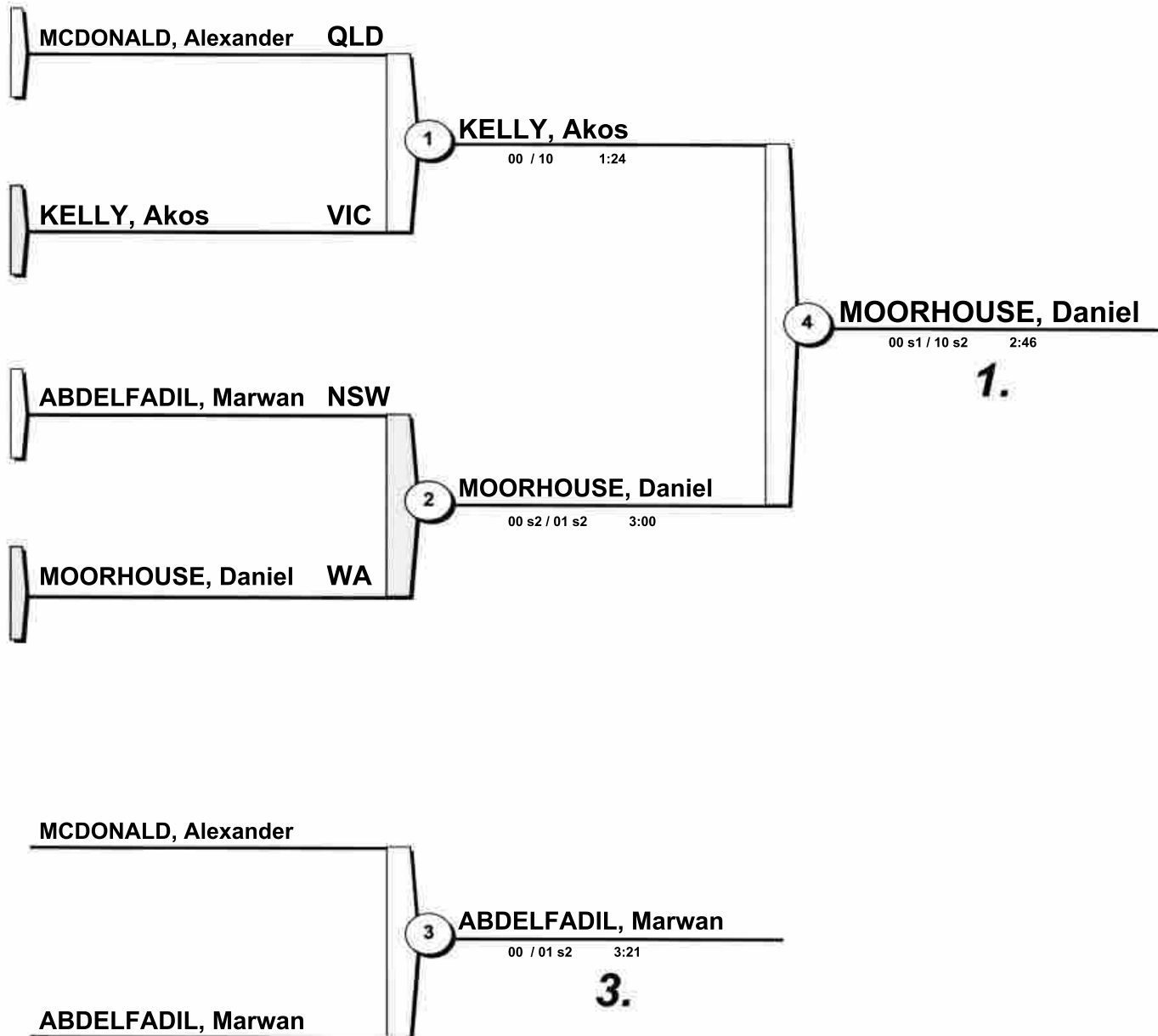

Final Results

1. MOORHOUSE, Daniel WA
2. KELLY, Akos VIC
3. ABDEL FADIL, Marwan NSW

2019 Australian National Championships

Cararra (AUS), 08 Jun 2019

-29 kg

8 Judoka

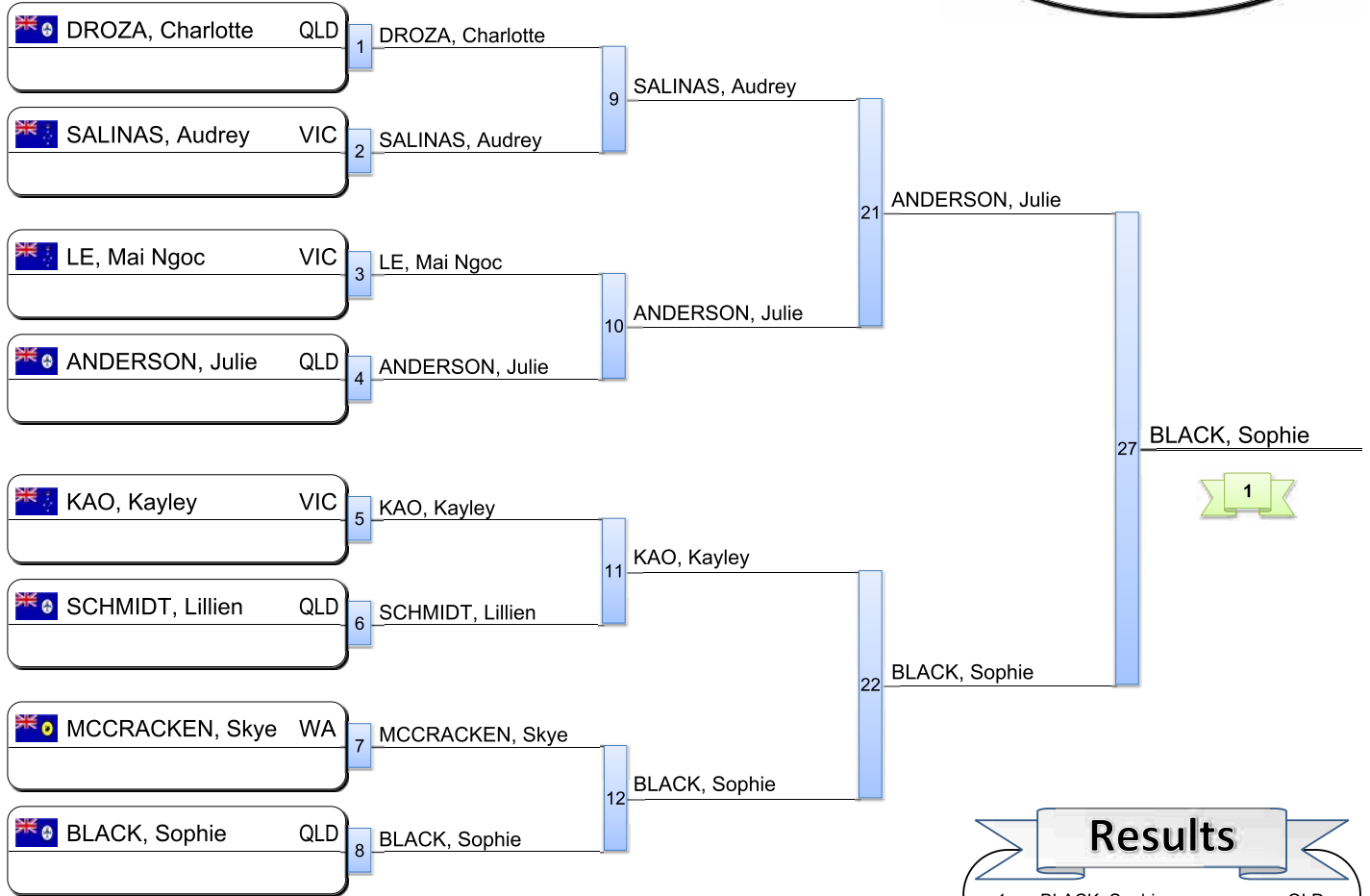

Results

- | | | |
|----|------------------|-----|
| 1. | BLACK, Sophie | QLD |
| 2. | ANDERSON, Julie | QLD |
| 3. | KAO, Kayley | VIC |
| 3. | SALINAS, Audrey | VIC |
| 5. | LE, Mai Ngoc | VIC |
| 5. | MCCRACKEN, Skye | WA |
| 7. | DROZA, Charlotte | QLD |
| 7. | SCHMIDT, Lillien | QLD |

Repechage

Loser contest will appear at in repechage

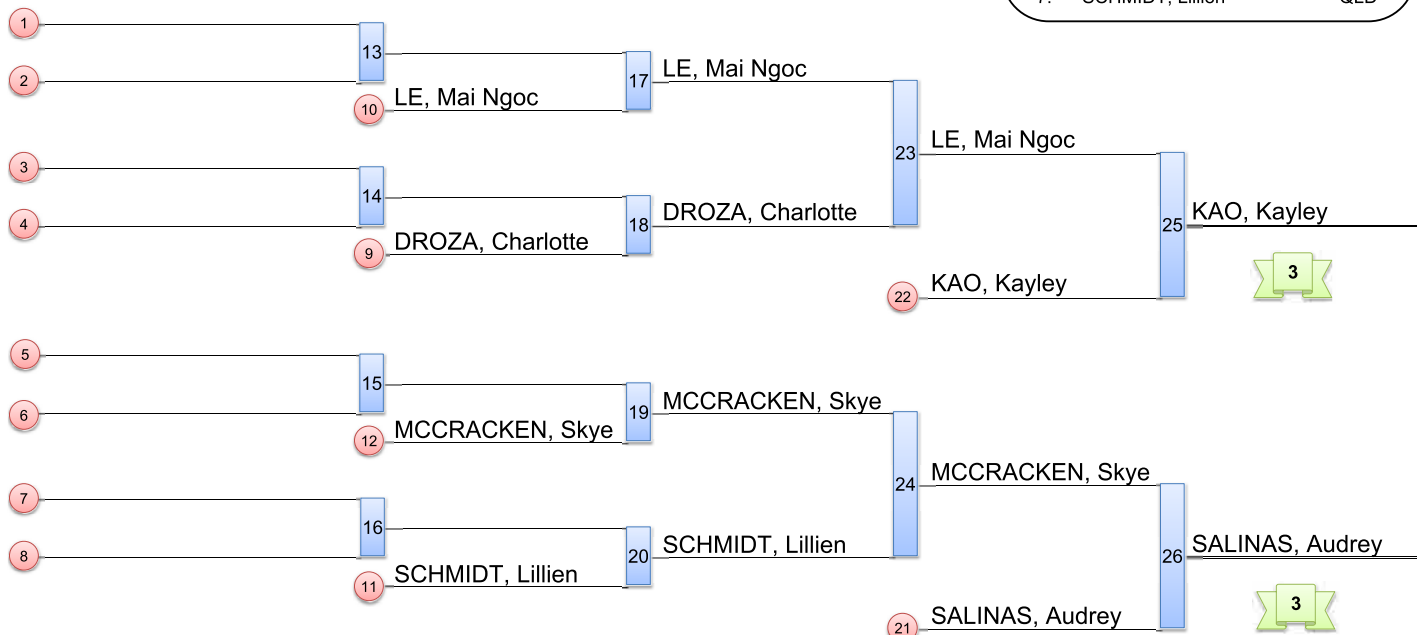

2019 Australian National Championships

Cararra (AUS), 08 Jun 2019

-32 kg

3 Judoka

			1	2	3	Wins Score	
1	ZOLLINGER, Lilly	NSW		1	0	1 0	
2	POWELL, Mary	NSW	0		0	0 0	
3	DIAS, Antonia	VIC	1	1		2 0	

1	ZOLLINGER, Lilly	NSW	1	ZOLLINGER, Lilly	NSW
2	POWELL, Mary	NSW		10 / 00	1:27

1	ZOLLINGER, Lilly	NSW	2	DIAS, Antonia	VIC
3	DIAS, Antonia	VIC		00 / 01 s1	3:00

2	POWELL, Mary	NSW	3	DIAS, Antonia	VIC
3	DIAS, Antonia	VIC		00 / 10	0:59

Final Results

- DIAS, Antonia VIC
- ZOLLINGER, Lilly NSW
-

2019 Australian National Championships

Cararra (AUS), 08 Jun 2019

-36 kg

9 Judoka

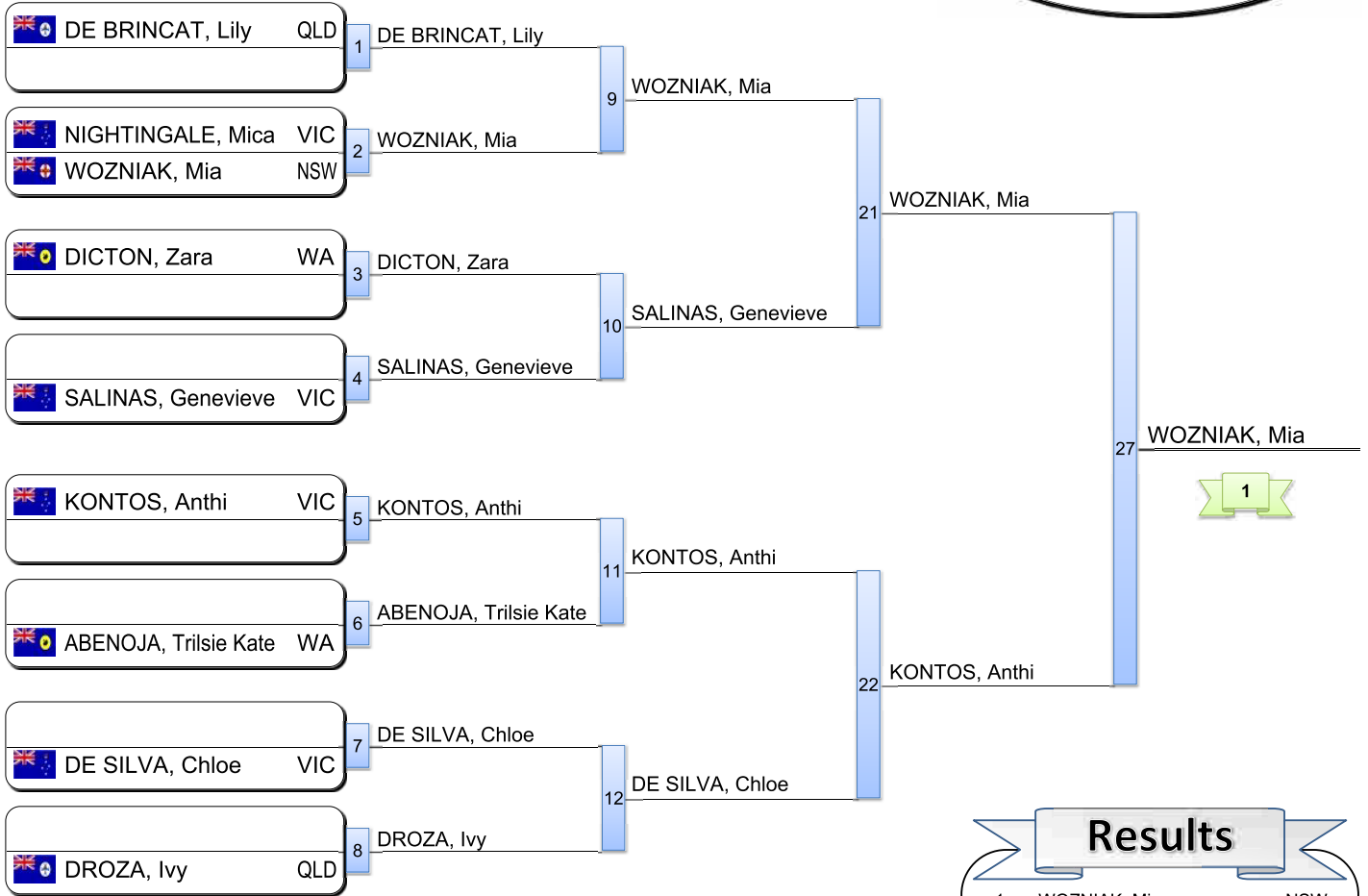

Results

- | | | |
|----|-----------------------|-----|
| 1. | WOZNIAK, Mia | NSW |
| 2. | KONTOS, Anthi | VIC |
| 3. | DE BRINCAT, Lily | QLD |
| 3. | SALINAS, Genevieve | VIC |
| 5. | DE SILVA, Chloe | VIC |
| 5. | ABENOJA, Trilsie Kate | WA |
| 7. | NIGHTINGALE, Mica | VIC |
| 7. | DROZA, Ivy | QLD |

Repechage

Loser contest will appear at in repechage

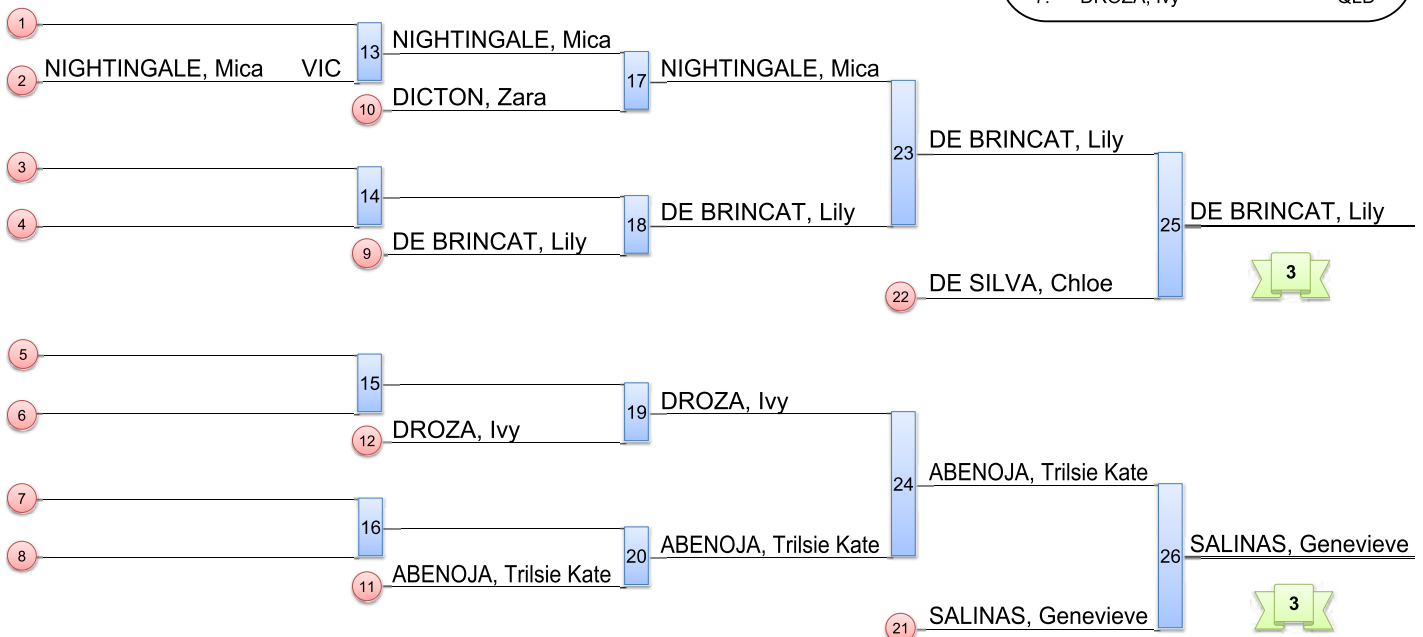

2019 Australian National Championships

Cararra (AUS), 08 Jun 2019

-40 kg

7 Judoka

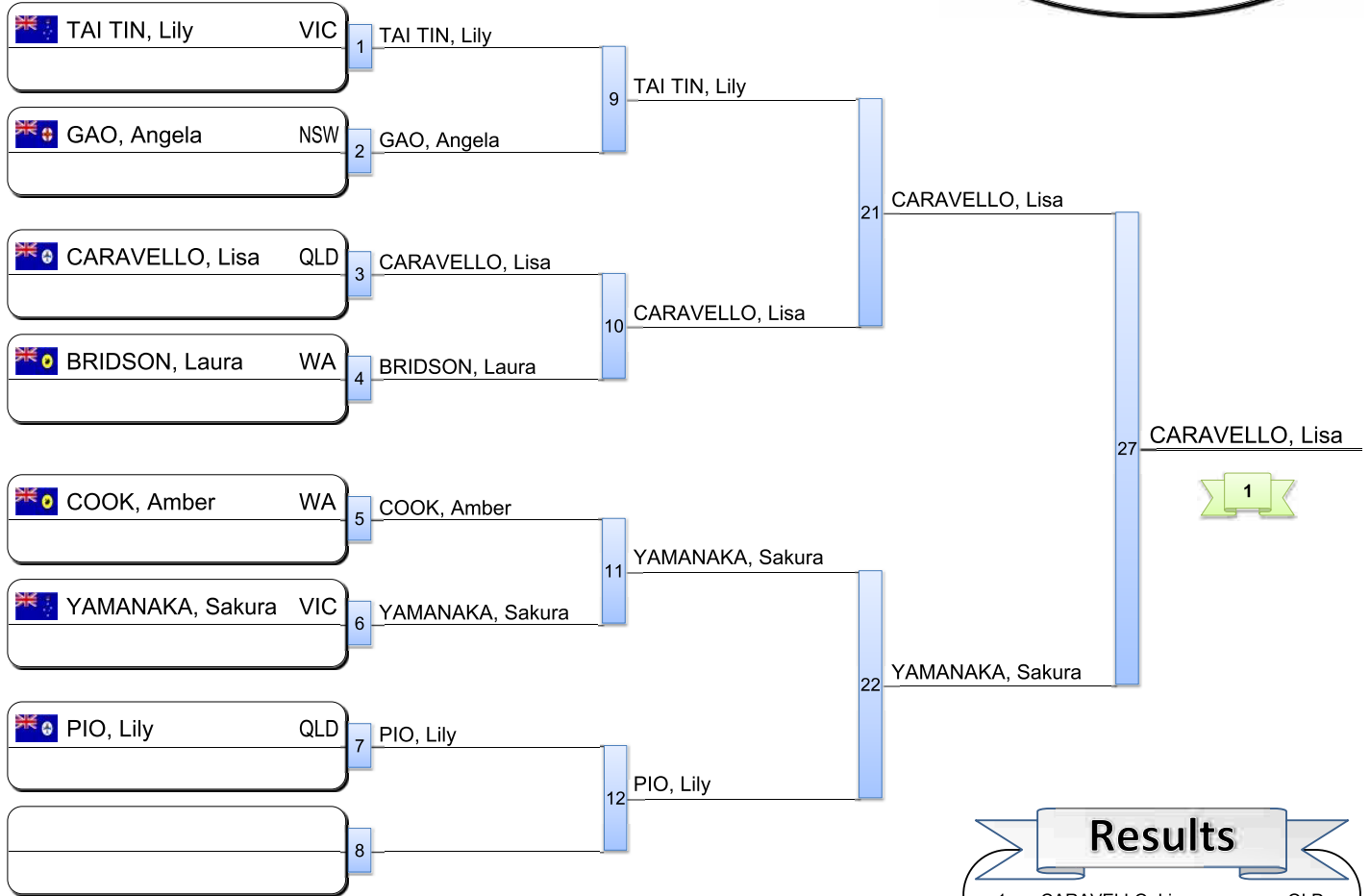

Results

1. CARAVELLO, Lisa QLD
2. YAMANAKA, Sakura VIC
3. BRIDSON, Laura WA
3. TAI TIN, Lily VIC
5. PIO, Lily QLD
5. COOK, Amber WA
7. GAO, Angela NSW
- 7.

Repechage

Loser contest will appear at in repechage

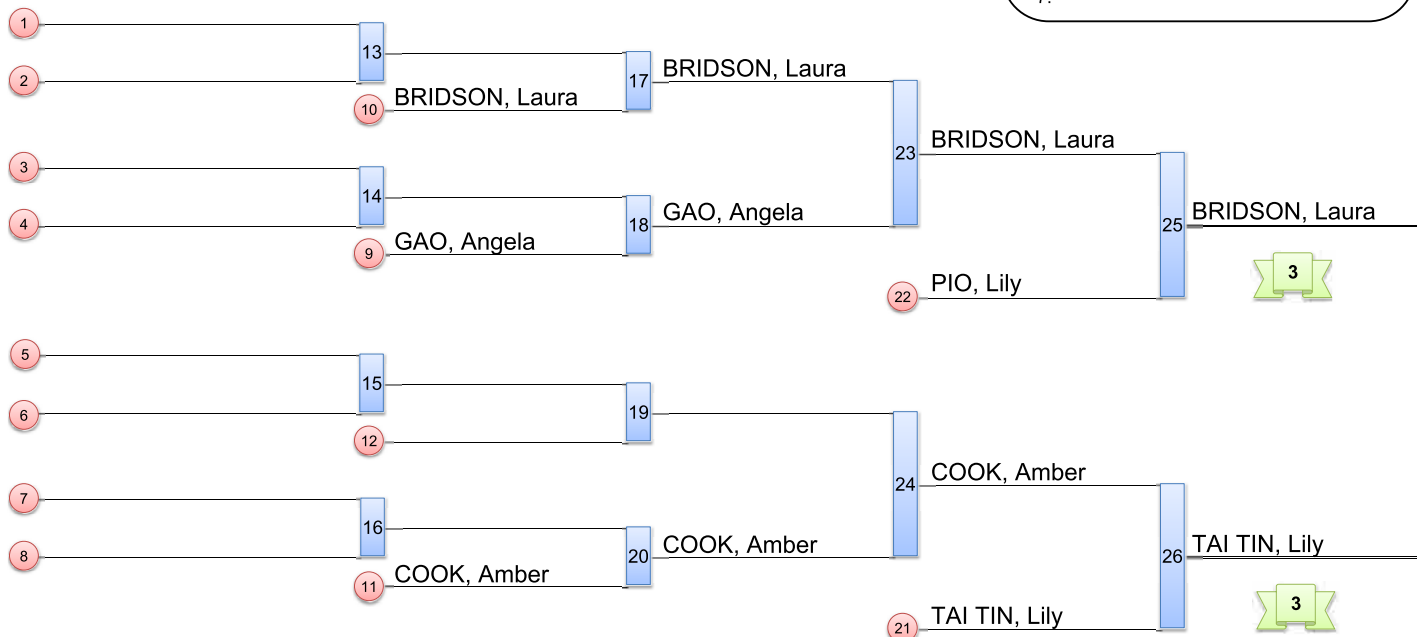

2019 Australian National Championships

Cararra (AUS), 08 Jun 2019

-48 kg

4 Judoka

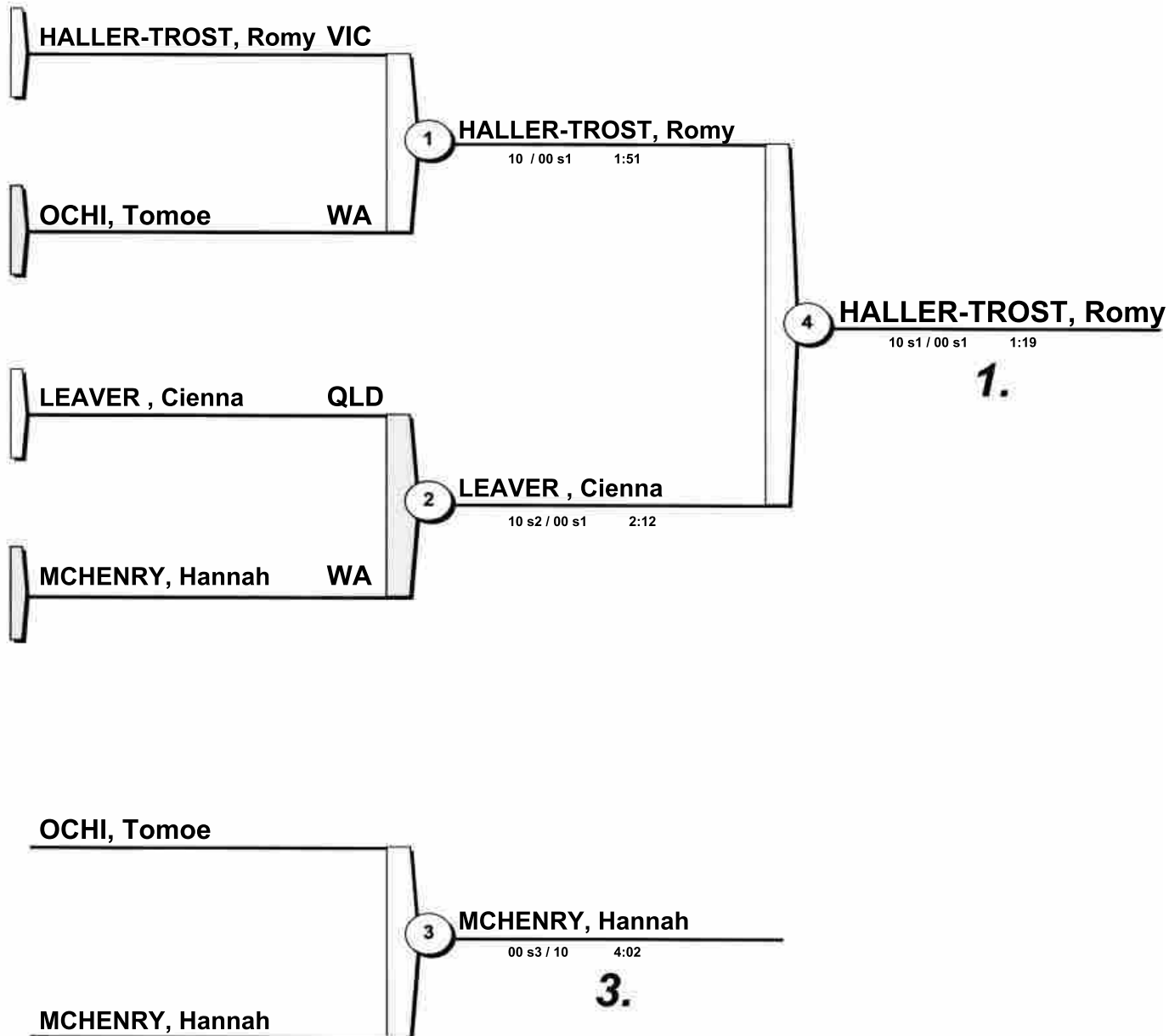

Final Results

1. HALLER-TROST, Romy VIC
2. LEAVER, Cienna QLD
3. MCHENRY, Hannah WA

1	NSW	TANDEAN, Bjorn	1	TANDEAN, Bjorn	10
9				New South Wales (NSW)	
5	ACT	EICHNER, Andrew	2	EICHNER, Andrew	0
13				Australian Capital Territory (ACT)	
3	QLD	GRIFFIN, Blaise	3	GRIFFIN, Blaise	0
11				Queensland (QLD)	
7	WA	BOXELL, Jordan	4	BOXELL, Jordan	10
15				Western Australia (WA)	
2	ACT	ARNOLD, Kristoperher	5	ARNOLD, Kristoperher	7
10				Australian Capital Territory (ACT)	
6	QLD	RIESTER, Henrik	6	RIESTER, Henrik	0
14				Queensland (QLD)	
4	SA	TRAN, Binh	7	TRAN, Binh	10
12				South Australia (SA)	
8	QLD	SPINOSA, Donata	8	MCKINNEY-SMITH, Jayden	0
16	NT	MCKINNEY-SMITH, Jayden	8	MCKINNEY-SMITH, Jayden	0
				Northern Territory (NT)	

9	TANDEAN, Bjorn	10
	New South Wales (NSW)	
17	TANDEAN, Bjorn	7
	New South Wales (NSW)	
10	BOXELL, Jordan	0
	Western Australia (WA)	
11	ARNOLD, Kristoperher	0
	Australian Capital Territory (ACT)	
18	TRAN, Binh	0
	South Australia (SA)	
12	TRAN, Binh	10
	South Australia (SA)	

23	TANDEAN, Bjorn	
	New South Wales (NSW)	
0	TRAN, Binh	
	South Australia (SA)	

RESULTS		
1	TANDEAN, Bjorn	NSW
2	TRAN, Binh	SA
3	EICHNER, Andrew	ACT
3	BOXELL, Jordan	WA
5	ARNOLD, Kristoperher	ACT
5	RIESTER, Henrik	QLD
7	GRIFFIN, Blaise	QLD
7	MCKINNEY-SMITH, Jayden	NT

13	EICHNER, Andrew	10
	Australian Capital Territory (ACT)	
14	GRIFFIN, Blaise	0
	Queensland (QLD)	
15	RIESTER, Henrik	10
	Queensland (QLD)	
16	MCKINNEY-SMITH, Jayden	0
	Northern Territory (NT)	

19	EICHNER, Andrew	10
	Australian Capital Territory (ACT)	
20	RIESTER, Henrik	0
	Queensland (QLD)	
22	BOXELL, Jordan	10
	Western Australia (WA)	

21	EICHNER, Andrew	
	Australian Capital Terr. (ACT)	
22	BOXELL, Jordan	
	Western Australia (WA)	

1	VIC	NIGHTINGALE, Noah	1	NIGHTINGALE, Noah	10
17	WA	BERTA, Andras	2	BERTA, Andras	0
9	TAS	AMANI, Eric	3	AMANI, Eric	0
21	ACT	MCGREGOR, Steve	0	CUTMORE, Elliott	7
13	QLD	CUTMORE, Elliott	10	CUTMORE, Elliott	10
29	TAS	MOELL, Ben	5	MOELL, Ben	0
3	QLD	SEDERKENNY, Mark	6	SEDERKENNY, Mark	10
19	VIC	LEE, Thomas	0	DALLMANN, William	0
11	QLD	DALLMANN, William	7	DALLMANN, William	0
27	WA	ELIOT, Bryce	8	ELIOT, Bryce	10
7	WA	JOHNSON, Nicholas	9	JOHNSON, Nicholas	10
23	NSW	MALINOWSKI, Alexander	10	MALINOWSKI, Alexander	0
15	WA	ORTIZ, Samuel	0	TAI TIN, Will	10
31	VIC	TAI TIN, Will	10	TAI TIN, Will	10
2	QLD	DALLMANN, Conor	12	DALLMANN, Conor	0
18	TAS	PRESS, Luke	10	PRESS, Luke	0
10	ACT	EICHNER, Michael	0	BRIGHT, Lloyd	10
26	WA	BRIGHT, Lloyd	14	BRIGHT, Lloyd	10
6	VIC	JOHN, Tim	15	JOHN, Tim	10
22	QLD	MOLL, Mark	16	MOLL, Mark	0

17	NIGHTINGALE, Noah	10
25	NIGHTINGALE, Noah	10
18	CUTMORE, Elliott	0
37	NIGHTINGALE, Noah	10
19	SEDERKENNY, Mark	10
26	SEDERKENNY, Mark	0
20	ELIOT, Bryce	0
21	JOHNSON, Nicholas	0
27	TAI TIN, Will	10
22	TAI TIN, Will	10
38	TAI TIN, Will	0
23	BRIGHT, Lloyd	0
28	JOHN, Tim	0
24	JOHN, Tim	10

25	NIGHTINGALE, Noah	10
37	NIGHTINGALE, Noah	10
43	NIGHTINGALE, Noah	10
27	TAI TIN, Will	10
38	TAI TIN, Will	0

RESULTS		
1	NIGHTINGALE, Noah	VIC
2	TAI TIN, Will	VIC
3	CUTMORE, Elliott	QLD
3	ORTIZ, Samuel	WA
5	JOHN, Tim	VIC
5	SEDERKENNY, Mark	QLD
7	MOELL, Ben	TAS
7	BRIGHT, Lloyd	WA

29	WA	BERTA, Andras	0	QLD	CUTMORE, Elliott	10
30	TAS	MOELL, Ben	10	39	CUTMORE, Elliott	10
31	WA	ORTIZ, Samuel	10	34	MOELL, Ben	0
31	QLD	DALLMANN, Conor	0	35	ORTIZ, Samuel	10
32	QLD	MOLL, Mark	0	40	ORTIZ, Samuel	10
32	WA	BRIGHT, Lloyd	10	42	ORTIZ, Samuel	10

39	CUTMORE, Elliott	10
41	CUTMORE, Elliott	0
40	ORTIZ, Samuel	10
42	ORTIZ, Samuel	0
40	SEDERKENNY, Mark	0

Judo Federation of Australia **2019 Australian National Championships**
Monday, 10 June 2019
Weight category: KYU Men -90 kg

-90 kg
(8 competitors)

1	KORIC, Kenan	0
	Queensland (QLD)	
5	O'HALLORAN, Jack	10
	Australian Capital Territory (ACT)	
3	FONG, Joshua	
	Northern Territory (NT)	
7	MCLAREN, Hamish	
	Tasmania (TAS)	
2	KALAMBOKAS, Andreas	10
	Northern Territory (NT)	
6	STEFFENS, Aaron	0
	Queensland (QLD)	
4	KHOKHLOV, George	10
	New South Wales (NSW)	
8	PANAGOPOULOS, Yianni	0
	Victoria (VIC)	

1	O'HALLORAN, Jack	10
	Australian Capital Territor. (ACT)	
5	MCLAREN, Hamish	0
	Tasmania (TAS)	

5	O'HALLORAN, Jack	0
	Australian Capital Territor. (ACT)	

11	KHOKHLOV, George
	New South Wales (NSW)

3	KALAMBOKAS, Andreas	0
	Northern Territory (NT)	
6	KHOKHLOV, George	10
	New South Wales (NSW)	

6	KHOKHLOV, George	10
	New South Wales (NSW)	

RESULTS		
1	KHOKHLOV, George	NSW
2	O'HALLORAN, Jack	ACT
3	KORIC, Kenan	QLD
3	MCLAREN, Hamish	TAS

7	KORIC, Kenan	
	Queensland (QLD)	

10	KORIC, Kenan	10
	Queensland (QLD)	

9	KORIC, Kenan
	Queensland (QLD)

8	STEFFENS, Aaron	0
	Queensland (QLD)	

0	KALAMBOKAS, Andreas	0
	Northern Territory (NT)	

10	PANAGOPOULOS, Y.	10
	Victoria (VIC)	

8	PANAGOPOULOS, Yianni	0
	Victoria (VIC)	

10	MCLAREN, Hamish
	Tasmania (TAS)

10	MCLAREN, Hamish	10
	Tasmania (TAS)	

1	MAR, Ryan New South Wales (NSW)	0
5	LAMBERT, Joshua Western Australia (WA)	7
3	SPRULES, James South Australia (SA)	10
7	COOK, Molnam Queensland (QLD)	0
2	HASELL, Ryan Queensland (QLD)	10
6	NORRIS, Tert Northern Territory (NT)	0
4	HUNT, Mike Queensland (QLD)	0
8	HITCHENS, Jake Tasmania (TAS)	10

1	LAMBERT, Joshua Western Australia (WA)	0
5	SPRULES, James South Australia (SA)	10

3	HASELL, Ryan Queensland (QLD)	0
6	HITCHENS, Jake Tasmania (TAS)	10

5	SPRULES, James South Australia (SA)	10
11	SPRULES, James South Australia (SA)	
6	HITCHENS, Jake Tasmania (TAS)	0

RESULTS		
1	SPRULES, James	SA
2	HITCHENS, Jake	TAS
3	HASELL, Ryan	QLD
3	LAMBERT, Joshua	WA

	MAR, Ryan New South Wales (NSW)	0
7	COOK, Molnam Queensland (QLD)	10
	NORRIS, Tert Northern Territory (NT)	0
8	HUNT, Mike Queensland (QLD)	10

	COOK, Molnam Queensland (QLD)	0
9	HASELL, Ryan Queensland (QLD)	10
	HUNT, Mike Queensland (QLD)	0
10	LAMBERT, Joshua Western Australia (WA)	10

	1	2	3	Fights won	Place
				Total points	
HOOGLAND, Ari [QLD]	1	1		2	1
	10000	10000		20	
SMITH, Vaughan [WA]	0		0		3
	00000		01001		
NORRIS, Michael [NT]		0	1	1	2
		00001	02000	10	

RESULTS		
1	NG, Carol	QLD
2	CONRAN, Srella	QLD
3	TUSIA, Louise	VIC

1	NG, Carol Queensland (QLD)	7
3	TUSIA, Louise Victoria (VIC)	0

2	CONRAN, Srella Queensland (QLD)	10
4	TAI TIN, Priscilla Victoria (VIC)	0

1	NG, Carol Queensland (QLD)	10
---	--------------------------------------	----

2	CONRAN, Srella Queensland (QLD)	0
---	---	---

	TUSIA, Louise Victoria (VIC)	10
--	--	----

	TAI TIN, Priscilla Victoria (VIC)	0
--	---	---

4	NG, Carol Queensland (QLD)
---	--------------------------------------

3	TUSIA, Louise Victoria (VIC)
---	--

RESULTS		
1	RAMETTA, Ryley	VIC
2	MADDOCKS, Nina	VIC
3	THOMAS, Matilda	WA

1	HA, Chloe New South Wales (NSW)	0
3	MADDOCKS, Nina Victoria (VIC)	10

2	RAMETTA, Ryley Victoria (VIC)	10
4	THOMAS, Matilda Western Australia (WA)	0

1	MADDOCKS, Nina Victoria (VIC)	0
---	---	---

2	RAMETTA, Ryley Victoria (VIC)	10
---	---	----

	HA, Chloe New South Wales (NSW)	0
--	---	---

	THOMAS, Matilda Western Australia (WA)	10
--	--	----

4	RAMETTA, Ryley Victoria (VIC)
---	---

3	THOMAS, Matilda Western Australia (WA)
---	--

RESULTS		
1	NEWMAN, Francis	QLD
2	BEVIS, Kristy	QLD
3	ADAMS, Christina	NSW

1	ADAMS, Christina New South Wales (NSW)	0
3	NEWMAN, Francis Queensland (QLD)	10

2	BEVIS, Kristy Queensland (QLD)	10
4	ABOUZIED, Maysa Victoria (VIC)	0

1	NEWMAN, Francis Queensland (QLD)	10
---	--	----

2	BEVIS, Kristy Queensland (QLD)	0
---	--	---

	ADAMS, Christina New South Wales (NSW)	10
--	--	----

	ABOUZIED, Maysa Victoria (VIC)	0
--	--	---

4	NEWMAN, Francis Queensland (QLD)
---	--

3	ADAMS, Christina New South Wales (NSW)
---	--

RESULTS		
1	FORBES, Sarah	WA
2	BRADBURY, Hannah	SA
3	BOULTBEE, Amy	TAS

1	FORBES, Sarah	10
	Western Australia (WA)	
3	BOULTBEE, Amy	0
	Tasmania (TAS)	

2	RADOVANICH, Brie Staria	0
	Northern Territory (NT)	
4	BRADBURY, Hannah	10
	South Australia (SA)	

1	FORBES, Sarah	10
	Western Australia (WA)	
2	BRADBURY, Hannah	0
	South Australia (SA)	

4	FORBES, Sarah	
	Western Australia (WA)	
3	BOULTBEE, Amy	10
	Tasmania (TAS)	
2	BRADBURY, Hannah	0
	South Australia (SA)	
3	BOULTBEE, Amy	
	Tasmania (TAS)	
2	RADOVANICH, Brie Staria	0
	Northern Territory (NT)	

	1	2	3	Fights won	Place
				Total points	
NIDERLA, Sylvia [VIC]	0	1		1	2
	00000	01002		1	
HUNT, Sally [ACT]	1		1	2	1
	02000		02000	20	
JOHANSSON-CRANFIELD, Klara [ACT]		0	0		3
		00002	00000		

Pool A

		1	3	4	
1	[VIC] JOHN, Tim		1		1
			10000		10
3				0	
				0	
5	[WA] BRIGHT, Lloyd		0	1	1
			00000	10	10

RESULTS		
1	MOLL, Mark	QLD
2	JOHN, Tim	VIC
3	LEE, Thomas	VIC



Judo Federation of Australia
2019 Australian National Championships
Monday, 10 June 2019
Weight category: Veteran Men 34-39 -66 kg

Contest	Name	Score	Score	Name	Time
1 - 2	MOLLOY, Jason New South Wales (NSW)	7	0	UYAMI, Lito Western Australia (WA)	3:00
1 - 2	MOLLOY, Jason New South Wales (NSW)	0	10	UYAMI, Lito Western Australia (WA)	0:27
1 - 2	MOLLOY, Jason New South Wales (NSW)	0	7	UYAMI, Lito Western Australia (WA)	3:00

Score points: Ippon 100 / Wazaari 10 / Yuko 1 / Yusei gachi 0,5

Criteria to define the winner: better of 2 contests, if 1 - 1 the third match will decide

RESULTS		
1	UYAMI, Lito	WA
2	MOLLOY, Jason	NSW

	1	2	3	Fights won	Place
				Total points	
SKINNER, Sean [TAS]	0	0			3
	00000	00000			
ROBERTS, Andrew [NSW]	1		0	1	2
	10000		00002	10	
YULDASHEV, Aziz [NSW]		1	1	2	1
		10000	01000	11	

Pool A

		1	3	4		
1	[VIC] LEGAUD, Christophe	1	1		2	1
		02000	10000		20	
3	[QLD] DE BRINCAT, Paul	0		1	1	2
		00000		10000	10	
5	[WA] WONG, Danny		0	0		3
			00000	00000		

RESULTS		
1	LEGAUD, Christophe	VIC
2	TRAN, Binh	SA
3	DE BRINCAT, Paul	QLD

1 [VIC] LEGAUD, Christophe

3 [QLD] DE BRINCAT, Paul	A
5 [WA] WONG, Danny	

2 ARNOLD, Kristoperher Australian Capital Territory (ACT)	0
4 TRAN, Binh South Australia (SA)	10

LEGAUD, Christophe Victoria (VIC)	10
TRAN, Binh South Australia (SA)	0

6 LEGAUD, Christophe
Victoria (VIC)

DE BRINCAT, Paul Queensland (QLD)	10
ARNOLD, Kristoperher Australian Capital Territory (ACT)	0

5 DE BRINCAT, Paul
Queensland (QLD)

	1	2	3	Fights won	Place
				Total points	
BERTA, Andras [WA]	1	0		1	2
	10000	00000		10	
FILMER, Aaron [QLD]	0		0		3
	00000		00000		
WHITE, Jason [NSW]		1	1	2	1
		02000	10000	20	

RESULTS		
1	MAYER, Miki	VIC
2	LAMBERT, Joshua	WA
3	COOK, Molnam	QLD

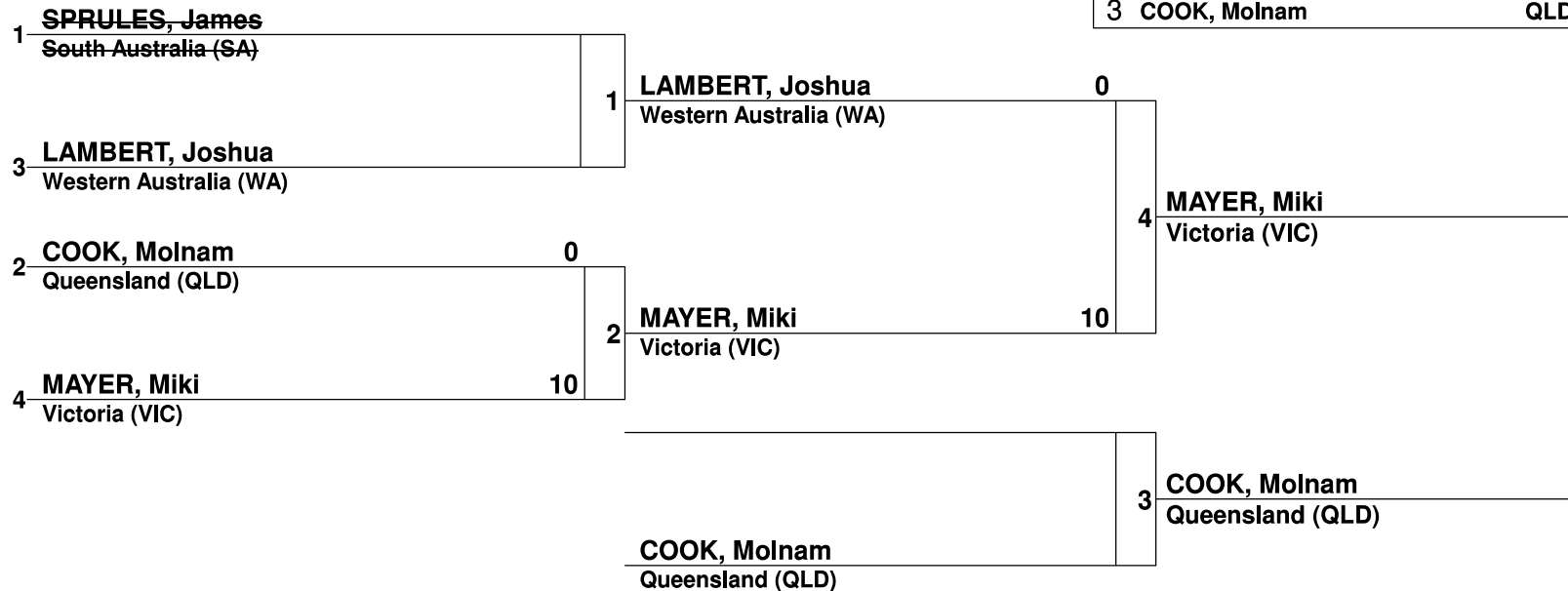

	1	2	3	Fights won	Place
				Total points	
NOACK, Doug [VIC]	1	0		1	2
	10001	00000		10	
TOURNIER, Luc [WA]	0		0		3
	00000		0		
PHIPPS, Wayne [WA]		1	1	2	1
		02000	10	20	

RESULTS		
1	EICHNER, David	ACT
2	RANTHILAKA, Rasika	ACT
3	MALINOWSKI, Alexander	NSW

1	MALINOWSKI, Alexander	0
	New South Wales (NSW)	
3	EICHNER, David	10
	Australian Capital Territory (ACT)	

2	MCGREGOR, Steve	0
	Australian Capital Territory (ACT)	
4	RANTHILAKA, Rasika	10
	Australian Capital Territory (ACT)	

1	EICHNER, David	10
	Australian Capital Territory (ACT)	

2	RANTHILAKA, Rasika	0
	Australian Capital Territory (ACT)	

	MALINOWSKI, Alexander	10
	New South Wales (NSW)	

	MCGREGOR, Steve	0
	Australian Capital Territory (ACT)	

4	EICHNER, David	
	Australian Capital Territory (ACT)	

3	MALINOWSKI, Alexander	
	New South Wales (NSW)	

Judo Federation of Australia
2019 Australian National Championships
Monday, 10 June 2019
Weight category: Veteran Men 45-49 -81 kg

Contest	Name	Score	Score	Name	Time
1 - 2	FINLEY, Joe Western Australia (WA)	10	0	O'DEA, Martin Western Australia (WA)	1:05
1 - 2	FINLEY, Joe Western Australia (WA)	0	10	O'DEA, Martin Western Australia (WA)	0:31
1 - 2	FINLEY, Joe Western Australia (WA)	0	10	O'DEA, Martin Western Australia (WA)	2:40

Score points: Ippon 100 / Wazaari 10 / Yuko 1 / Yusei gachi 0,5

Criteria to define the winner: better of 2 contests, if 1 - 1 the third match will decide

RESULTS		
1	O'DEA, Martin	WA
2	FINLEY, Joe	WA

Pool A

		1	3	4		
1	[QLD] KORIC, Kenan	0	0			3
		01000	00001			
3	[QLD] TAYLOR, John	1		0	1	2
		10002		00002	10	
5	[VIC] RAMETTA, Bernie		1	1	2	1
			10001	10002	20	

RESULTS		
1	SCHMIDT, Andreas	QLD
2	RAMETTA, Bernie	VIC
3	TAYLOR, John	QLD

1	[QLD] KORIC, Kenan				
3	[QLD] TAYLOR, John	A	RAMETTA, Bernie	0	
			Victoria (VIC)		
5	[VIC] RAMETTA, Bernie				6
2	SCHMIDT, Andreas Queensland (QLD)	10			
		2	SCHMIDT, Andreas	10	
			Queensland (QLD)		
4	STEFFENS, Aaron Queensland (QLD)	0			
			TAYLOR, John	10	
			Queensland (QLD)		
					5
			STEFFENS, Aaron	0	
			Queensland (QLD)		

Judo Federation of Australia
2019 Australian National Championships
Monday, 10 June 2019
Weight category: Veteran Men 50-54 -66 kg

Contest	Name	Score	Score	Name	Time
1 - 2	MCKENZIE, Ken New South Wales (NSW)	0	10	GIBBONS, Colin New South Wales (NSW)	1:51
1 - 2	MCKENZIE, Ken New South Wales (NSW)	10	0	GIBBONS, Colin New South Wales (NSW)	5:17
1 - 2	MCKENZIE, Ken New South Wales (NSW)	0	10	GIBBONS, Colin New South Wales (NSW)	1:52

Score points: Ippon 100 / Wazaari 10 / Yuko 1 / Yusei gachi 0,5

Criteria to define the winner: better of 2 contests, if 1 - 1 the third match will decide

RESULTS		
1	GIBBONS, Colin	NSW
2	MCKENZIE, Ken	NSW

RESULTS		
1	FARRINGTON, Craig	VIC
2	YOUNG, Scott	NSW
3	NIGHTINGALE, Vin	VIC

1	NIGHTINGALE, Vin	0
	Victoria (VIC)	
3	YOUNG, Scott	10
	New South Wales (NSW)	

2	FARRINGTON, Craig	10
	Victoria (VIC)	
4	SIMMONDS, Clive	0
	New South Wales (NSW)	

1	YOUNG, Scott	0
	New South Wales (NSW)	

2	FARRINGTON, Craig	10
	Victoria (VIC)	

	NIGHTINGALE, Vin	10
	Victoria (VIC)	

	SIMMONDS, Clive	0
	New South Wales (NSW)	

4	FARRINGTON, Craig
	Victoria (VIC)

3	NIGHTINGALE, Vin
	Victoria (VIC)

	1	2	3	Fights won	Place
				Total points	
LINDSAY, Tony [NSW]	1	1		2	1
	10000	01001		11	
VARI, Frank [VIC]	0		0		3
	00001		00001		
BATTINO, John [QLD]		0	1	1	2
		00001	10001	10	

RESULTS		
1	HOBBY, Brenton	SA
2	CASAS, Omar	VIC
3	MIDDLETON, Peter	WA

1	WATKINS, John	0
	Australian Capital Territory (ACT)	
3	CASAS, Omar	10
	Victoria (VIC)	

2	MIDDLETON, Peter	0
	Western Australia (WA)	
4	HOBBY, Brenton	10
	South Australia (SA)	

1	CASAS, Omar	0
	Victoria (VIC)	

2	HOBBY, Brenton	10
	South Australia (SA)	

	WATKINS, John	0
	Australian Capital Territory (ACT)	

	MIDDLETON, Peter	10
	Western Australia (WA)	

4	HOBBY, Brenton	
	South Australia (SA)	

3	MIDDLETON, Peter	
	Western Australia (WA)	

Judo Federation of Australia
2019 Australian National Championships
Monday, 10 June 2019
Weight category: Veteran Men 55-59 -81 kg

Contest	Name	Score	Score	Name	Time
---------	------	-------	-------	------	------

1 - 2	BELL, Andrew Queensland (QLD)	0	10	RICHARDSON, Hunter Victoria (VIC)	3:00
-------	----------------------------------	---	----	--------------------------------------	------

1 - 2	BELL, Andrew Queensland (QLD)	0	10	RICHARDSON, Hunter Victoria (VIC)	1:51
-------	----------------------------------	---	----	--------------------------------------	------

1 - 2	BELL, Andrew Queensland (QLD)			RICHARDSON, Hunter Victoria (VIC)	
-------	----------------------------------	--	--	--------------------------------------	--

Score points: Ippon 100 / Wazaari 10 / Yuko 1 / Yusei gachi 0,5

Criteria to define the winner: better of 2 contests, if 1 - 1 the third match will decide

RESULTS		
1	RICHARDSON, Hunter	VIC
2	BELL, Andrew	QLD

RESULTS		
1	ANDJELKOVIC, Srdjan	QLD
2	NABULSI, David	VIC
3	ENDICOTT-DAVIES, Morgan	NSW

1	ENDICOTT-DAVIES, Morgan	0
	New South Wales (NSW)	
3	ANDJELKOVIC, Srdjan	10
	Queensland (QLD)	

2	NABULSI, David	10
	Victoria (VIC)	
4	MISIUN, Slawek	0
	Western Australia (WA)	

1	ANDJELKOVIC, Srdjan	7
	Queensland (QLD)	

2	NABULSI, David	0
	Victoria (VIC)	

	ENDICOTT-DAVIES, Morgan	10
	New South Wales (NSW)	

	MISIUN, Slawek	0
	Western Australia (WA)	

4	ANDJELKOVIC, Srdjan
	Queensland (QLD)

3	ENDICOTT-DAVIES, Morgan
	New South Wales (NSW)

RESULTS		
1	BARKER, Xavier	QLD
2	SMITH, Vaughan	WA
3	MARLOW, Dean	WA

1	BARKER, Xavier	10
	Queensland (QLD)	
3	MARLOW, Dean	0
	Western Australia (WA)	

2	SMITH, Vaughan	10
	Western Australia (WA)	
4	MAUGER, Allen	0
	New South Wales (NSW)	

1	BARKER, Xavier	7
	Queensland (QLD)	

2	SMITH, Vaughan	0
	Western Australia (WA)	

	MARLOW, Dean	10
	Western Australia (WA)	

	MAUGER, Allen	0
	New South Wales (NSW)	

4	BARKER, Xavier	
	Queensland (QLD)	

3	MARLOW, Dean	
	Western Australia (WA)	

Judo Federation of Australia
2019 Australian National Championships
Monday, 10 June 2019
Weight category: Veteran Women 35-39 -57 kg

Contest	Name	Score	Score	Name	Time
---------	------	-------	-------	------	------

1 - 2	HAYASHI, Yumiko Queensland (QLD)	10	0	THOMAS, Matilda Western Australia (WA)	1:27
-------	-------------------------------------	----	---	---	------

1 - 2	HAYASHI, Yumiko Queensland (QLD)	10	0	THOMAS, Matilda Western Australia (WA)	2:48
-------	-------------------------------------	----	---	---	------

1 - 2	HAYASHI, Yumiko Queensland (QLD)			THOMAS, Matilda Western Australia (WA)	
-------	-------------------------------------	--	--	---	--

Score points: Ippon 100 / Wazaari 10 / Yuko 1 / Yusei gachi 0,5

Criteria to define the winner: better of 2 contests, if 1 - 1 the third match will decide

RESULTS		
1	HAYASHI, Yumiko	QLD
2	THOMAS, Matilda	WA

Judo Federation of Australia
2019 Australian National Championships
Monday, 10 June 2019
Weight category: Veteran Women 50-54 -78 kg

Contest	Name	Score	Score	Name	Time
---------	------	-------	-------	------	------

1 - 2	MALINOWSKA, Yekaterina New South Wales (NSW)	0	10	FORBES, Sarah Western Australia (WA)	4:13
-------	---	---	----	---	------

1 - 2	MALINOWSKA, Yekaterina New South Wales (NSW)	0	10	FORBES, Sarah Western Australia (WA)	2:20
-------	---	---	----	---	------

1 - 2	MALINOWSKA, Yekaterina New South Wales (NSW)			FORBES, Sarah Western Australia (WA)	
-------	---	--	--	---	--

Score points: Ippon 100 / Wazaari 10 / Yuko 1 / Yusei gachi 0,5

Criteria to define the winner: better of 2 contests, if 1 - 1 the third match will decide

RESULTS		
1	FORBES, Sarah	WA
2	MALINOWSKA, Yekaterina	NSW

Judo Federation of Australia
2019 Australian National Championships
Monday, 10 June 2019
Weight category: Veteran Women 50-54 +78 kg

Contest	Name	Score	Score	Name	Time
---------	------	-------	-------	------	------

1 - 2	NIDERLA, Sylvia Victoria (VIC)	0	10	RASMUSSEN, Anna Queensland (QLD)	1:14
-------	-----------------------------------	---	----	-------------------------------------	------

1 - 2	NIDERLA, Sylvia Victoria (VIC)	0	10	RASMUSSEN, Anna Queensland (QLD)	1:18
-------	-----------------------------------	---	----	-------------------------------------	------

1 - 2	NIDERLA, Sylvia Victoria (VIC)			RASMUSSEN, Anna Queensland (QLD)	
-------	-----------------------------------	--	--	-------------------------------------	--

Score points: Ippon 100 / Wazaari 10 / Yuko 1 / Yusei gachi 0,5

Criteria to define the winner: better of 2 contests, if 1 - 1 the third match will decide

RESULTS		
1	RASMUSSEN, Anna	QLD
2	NIDERLA, Sylvia	VIC

Pool A

		1	3	4		
1	[VIC] LEE, Thomas	0	0			3
		00000	0			
3	[VIC] JOHN, Tim	1		0	1	2
		01000		00000	10	
5	[QLD] MOLL, Mark		1	1	2	1
			10	01000	20	

RESULTS		
1	MOLL, Mark	QLD
2	TAI TIN, Will	VIC
3	JOHN, Tim	VIC

1	[VIC] LEE, Thomas					
3	[VIC] JOHN, Tim	A	MOLL, Mark	10		
5	[QLD] MOLL, Mark		Queensland (QLD)		6	MOLL, Mark Queensland (QLD)
2	TAI TIN, Will Victoria (VIC)	10				
4	BRIGHT, Lloyd Western Australia (WA)	0		2	TAI TIN, Will Victoria (VIC)	
			JOHN, Tim Victoria (VIC)	10		
			BRIGHT, Lloyd Western Australia (WA)	0	5	JOHN, Tim Victoria (VIC)

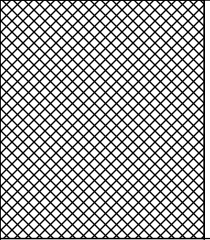
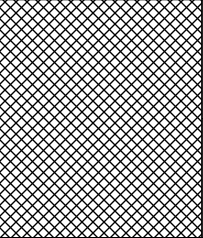
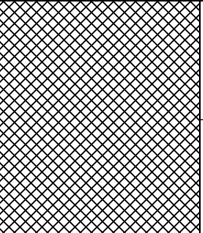
	1	2	3	Fights won	Place
				Total points	
BERTA., Andras [WA]	1	1		2	1
	01000	02000		20	
MCGREGOR, Steve [ACT]	0		0		3
	00000		00001		
FILMER., Aaron [QLD]		0	1	1	2
		00000	02001	10	

	1	2	3	Fights won	Place
				Total points	
FARRINGTON, Craig [VIC]	1	0		1	2
	10001	00002		10	
FINLEY., Joe [WA]	0		1	1	1
	00001		10002	10	
O'DEA., Martin [WA]		1	0	1	3
		01002	0000	1	

RESULTS		
1	TAYLOR., John	QLD
2	RAMETTA., Bernie	VIC
3	STEFFENS., Aaron	QLD

1	RAMETTA., Bernie	10
	Victoria (VIC)	
3	STEFFENS., Aaron	0
	Queensland (QLD)	

2	TAYLOR., John	10
	Queensland (QLD)	
4	HOGBEN, Aaron	0
	New South Wales (NSW)	

1	RAMETTA., Bernie	0
	Victoria (VIC)	

2	TAYLOR., John	10
	Queensland (QLD)	

	STEFFENS., Aaron	10
	Queensland (QLD)	

	HOGBEN, Aaron	0
	New South Wales (NSW)	

4	TAYLOR., John	
	Queensland (QLD)	

3	STEFFENS., Aaron	
	Queensland (QLD)	

	1	2	3	Fights won	Place
				Total points	
MARLOW., Dean [WA]	1	1		2	1
	10000	10000		20	
SMITH, Vaughan [WA]	0		1	1	2
	00000		10000	10	
SMITH, Sean [QLD]		0	0		3
		00000	00000		

	1	2	3	Fights won	Place
				Total points	
ROZIS, Nick [QLD]	0	0			3
	00000	00000			
SKINNER., Sean [TAS]	1		1	2	1
	10000		10000	20	
YOUNG, Scott [NSW]		1	0	1	2
		10001	00001	10	

	1	2	3	Fights won	Place
				Total points	
MISIUN, Slawek [WA]	0	0			3
	0100	00000			
VARI., Frank [VIC]	1		1	2	1
	10000		10000	20	
BATTINO., John [QLD]		1	0	1	2
		10000	00000	10	

Judo Federation of Australia
2019 Australian National Championships
Monday, 10 June 2019
Weight category: No Limits Men C1 -81 kg

		Fill in winning score			Wins	Points	Place	
	Name	Nation	1	2				3
1	CHAMPION, Nicholas [South Australia (SA)]	SA		0	0	0	0	3
2	WOOLLATT-PROSSER, Sha [South Australia (SA)]	SA	10		10	2	20	1
3	LEWIS, Benjamin [Queensland (QLD)]	QLD	10	0		1	10	2

Order of Contests: 1 - 2 / 1 - 3 / 2 - 3

Contest	Name	Score	Score	Name	Time
1 - 2	CHAMPION, Nicholas South Australia (SA)	0	10	WOOLLATT-PROSSER, S. South Australia (SA)	0:40
1 - 3	CHAMPION, Nicholas South Australia (SA)	0	10	LEWIS, Benjamin Queensland (QLD)	0:25
2 - 3	WOOLLATT-PROSSER, S. South Australia (SA)	10	0	LEWIS, Benjamin Queensland (QLD)	0:45

Score points: Ippon 10 / Waza-ari 1 / Penalties 0

Judo Federation of Australia
2019 Australian National Championships
Monday, 10 June 2019
Weight category: No Limits Men C1 -90 kg

Contest	Name	Score	Score	Name	Time
1 - 2	MORRIS, Adam New South Wales (NSW)	10	0	FITZPATRICK, Jake New South Wales (NSW)	1:55
1 - 2	MORRIS, Adam New South Wales (NSW)	0	10	FITZPATRICK, Jake New South Wales (NSW)	0:02
1 - 2	MORRIS, Adam New South Wales (NSW)	0	10	FITZPATRICK, Jake New South Wales (NSW)	0:32

Score points: Ippon 100 / Wazaari 10 / Yuko 1 / Yusei gachi 0,5

Criteria to define the winner: better of 2 contests, if 1 - 1 the third match will decide

RESULTS		
1	FITZPATRICK, Jake	NSW
2	MORRIS, Adam	NSW

Judo Federation of Australia
2019 Australian National Championships
Monday, 10 June 2019
Weight category: No Limits Men C2 -60 kg

		Fill in winning score			Wins	Points	Place	
	Name	Nation	1	2				3
1	TANDEAN, Bernhard [New South Wales (NSW)]	NSW		10	10	2	20	1
2	ZEITH, Jack [Queensland (QLD)]	QLD	0		10	1	10	2
3	HUDSON, Liam [South Australia (SA)]	SA	0	0		0	0	3

Order of Contests: 1 - 2 / 1 - 3 / 2 - 3

Contest	Name	Score	Score	Name	Time
1 - 2	TANDEAN, Bernhard New South Wales (NSW)	10	0	ZEITH, Jack Queensland (QLD)	0:13
1 - 3	TANDEAN, Bernhard New South Wales (NSW)	10	0	HUDSON, Liam South Australia (SA)	0:43
2 - 3	ZEITH, Jack Queensland (QLD)	10	0	HUDSON, Liam South Australia (SA)	1:00

Score points: Ippon 10 / Waza-ari 1 / Penalties 0

Judo Federation of Australia
2019 Australian National Championships
Monday, 10 June 2019
Weight category: No Limits Men C2 -66 kg

Contest	Name	Score	Score	Name	Time
---------	------	-------	-------	------	------

1 - 2	TANDEAN, Bernhard New South Wales (NSW)	10	0	MCGHEE, Joel Western Australia (WA)	1:09
-------	--	----	---	--	------

1 - 2	TANDEAN, Bernhard New South Wales (NSW)	10	0	MCGHEE, Joel Western Australia (WA)	3:00
-------	--	----	---	--	------

1 - 2	TANDEAN, Bernhard New South Wales (NSW)			MCGHEE, Joel Western Australia (WA)	
-------	--	--	--	--	--

Score points: Ippon 100 / Wazaari 10 / Yuko 1 / Yusei gachi 0,5

Criteria to define the winner: better of 2 contests, if 1 - 1 the third match will decide

RESULTS		
1	TANDEAN, Bernhard	NSW
2	MCGHEE, Joel	WA

Judo Federation of Australia
2019 Australian National Championships
Monday, 10 June 2019
Weight category: No Limits Men C2 -81 kg

		Fill in winning score						
	Name	Nation	1	2	3	Wins	Points	Place
1	LAFFY, James [Queensland (QLD)]	QLD		0	0	0	0	3
2	MILLIGAN WEBSTER, Ethan [New South Wales (NSW)]	NSW	10		0	1	10	2
3	VARNEY, Josiah [New South Wales (NSW)]	NSW	10	10		2	20	1

Order of Contests: 1 - 2 / 1 - 3 / 2 - 3

Contest	Name	Score	Score	Name	Time
1 - 2	LAFFY, James Queensland (QLD)	0	10	MILLIGAN WEBSTER, E. New South Wales (NSW)	2:47
1 - 3	LAFFY, James Queensland (QLD)	0	10	VARNEY, Josiah New South Wales (NSW)	1:11
2 - 3	MILLIGAN WEBSTER, E. New South Wales (NSW)	0	10	VARNEY, Josiah New South Wales (NSW)	0:37

Score points: Ippon 10 / Waza-ari 1 / Penalties 0

Judo Federation of Australia
2019 Australian National Championships
Monday, 10 June 2019
Weight category: No Limits Men C2 +90 kg

		Fill in winning score							
	Name	Nation	1	2	3	4	Wins	Points	Place
1	NOTARIANNI-ELLIS, Alex [South Australia (SA)]	SA		0	10	0	1	10	2
2	PICKET, Nicholas [New South Wales (NSW)]	NSW	10		0	0	1	10	4
3	ANDREWS, Dominic [New South Wales (NSW)]	NSW	0	10		0	1	10	3
4	FITZPATRICK, Jake [New South Wales (NSW)]	NSW	10	10	1		3	21	1

Score points: Ippon 10 / Waza-ari 1 / Penalties 0

Order of Contests: 1 - 2, 3 - 4 / 1 - 3, 2 - 4 / 1 - 4, 2 - 3

Contest	Name	Score	Score	Name	Time
1 - 2	NOTARIANNI-ELLIS, Alex South Australia (SA)	0	10	PICKET, Nicholas New South Wales (NSW)	1:24
3 - 4	ANDREWS, Dominic New South Wales (NSW)	0	7	FITZPATRICK, Jake New South Wales (NSW)	3:00
1 - 3	NOTARIANNI-ELLIS, Alex South Australia (SA)	10	0	ANDREWS, Dominic New South Wales (NSW)	0:14
2 - 4	PICKET, Nicholas New South Wales (NSW)	0	10	FITZPATRICK, Jake New South Wales (NSW)	0:40
1 - 4	NOTARIANNI-ELLIS, Alex South Australia (SA)	0	10	FITZPATRICK, Jake New South Wales (NSW)	0:26
2 - 3	PICKET, Nicholas New South Wales (NSW)	0	10	ANDREWS, Dominic New South Wales (NSW)	0:33

Judo Federation of Australia
2019 Australian National Championships
Monday, 10 June 2019
Weight category: No Limits Men Friendly -50 kg

		Fill in winning score			Wins	Points	Place
	Name	Nation	1	2			
1	NVOTA, Michael [Western Australia (WA)]	WA					
2	SCHMIDT, Max [Western Australia (WA)]	WA					
3	LEAVER, Seth [Western Australia (WA)]	WA					

Order of Contests: 1 - 2 / 1 - 3 / 2 - 3

Contest	Name	Score	Score	Name	Time
1 - 2	NVOTA, Michael Western Australia (WA)			SCHMIDT, Max Western Australia (WA)	
1 - 3	NVOTA, Michael Western Australia (WA)			LEAVER, Seth Western Australia (WA)	
2 - 3	SCHMIDT, Max Western Australia (WA)			LEAVER, Seth Western Australia (WA)	

Score points: Ippon 10 / Waza-ari 1 / Penalties 0

Judo Federation of Australia
2019 Australian National Championships
Monday, 10 June 2019
Weight category: No Limits Women C1 +70 kg

Contest	Name	Score	Score	Name	Time
1 - 2	GAUDRY, Onica New South Wales (NSW)	0	10	ROSE, Alison New South Wales (NSW)	1:39
1 - 2	GAUDRY, Onica New South Wales (NSW)	10	0	ROSE, Alison New South Wales (NSW)	0:05
1 - 2	GAUDRY, Onica New South Wales (NSW)	10	0	ROSE, Alison New South Wales (NSW)	2:25

Score points: Ippon 100 / Wazaari 10 / Yuko 1 / Yusei gachi 0,5

Criteria to define the winner: better of 2 contests, if 1 - 1 the third match will decide

RESULTS		
1	GAUDRY, Onica	NSW
2	ROSE, Alison	NSW

Judo Federation of Australia
2019 Australian National Championships
Monday, 10 June 2019
Weight category: No Limits Women C2 -78 kg

		Fill in winning score			Wins	Points	Place
	Name	Nation	1	2			
1	MCCREDDEN, Lynne [New South Wales (NSW)]	NSW		0	1	1	2
2	GAUDRY, Aleah [New South Wales (NSW)]	NSW	10		0	1	10
3	ABOUZIED, Maysa [Victoria (VIC)]	VIC	0	1		1	1

Order of Contests: 1 - 2 / 1 - 3 / 2 - 3

Contest	Name	Score	Score	Name	Time
1 - 2	MCCREDDEN, Lynne New South Wales (NSW)	0	10	GAUDRY, Aleah New South Wales (NSW)	2:56
1 - 3	MCCREDDEN, Lynne New South Wales (NSW)	7	0	ABOUZIED, Maysa Victoria (VIC)	3:00
2 - 3	GAUDRY, Aleah New South Wales (NSW)	0	7	ABOUZIED, Maysa Victoria (VIC)	3:00

Score points: Ippon 10 / Waza-ari 1 / Penalties 0

Judo Federation of Australia
2019 Australian National Championships
Monday, 10 June 2019
Weight category: No Limits Women C3 -70 kg

		Fill in winning score			Wins	Points	Place	
	Name	Nation	1	2				3
1	ABOUZIED, Maysa [Victoria (VIC)]	VIC		10	1	2	11	1
2	DUNN, Casey [Western Australia (WA)]	WA	0		0	0	0	3
3	GAUDRY, Aleah [New South Wales (NSW)]	NSW	0	10		1	10	2

Order of Contests: 1 - 2 / 1 - 3 / 2 - 3

Contest	Name	Score	Score	Name	Time
1 - 2	ABOUZIED, Maysa Victoria (VIC)	10	0	DUNN, Casey Western Australia (WA)	1:29
1 - 3	ABOUZIED, Maysa Victoria (VIC)	7	0	GAUDRY, Aleah New South Wales (NSW)	3:00
2 - 3	DUNN, Casey Western Australia (WA)	0	10	GAUDRY, Aleah New South Wales (NSW)	3:00

Score points: Ippon 10 / Waza-ari 1 / Penalties 0

2019 National Championships						
Junior Nage No Kata		TORI		UKE		Rank
Pair 3	NSW	Bernard	Tandean	Bianca	Tandean	1
Pair 1	VIC	Francis	D'Cousto	Romy	Haller-Trost	2
Pair 2	VIC	Ryan	Lim	Francis	D'Cousto	3
Goshin Jitsu						
		TORI		UKE		Rank
Pair 3	NSW	Matthew	Holmes	Greg	Cadorin	1
Pair 2	NSW	David	Willison	Marcus	Truppel	2
Pair 1	VIC	William	Murray	David	Nabulsi	3
Nage No Kata						
		TORI		UKE		Rank
Pair 6	NSW	Edmund	Yuen	Andras	Koltai	1
Pair 1	QLD	Blake	Murray	Michael	Pennisi	2
Pair 5	VIC	Vin	Nightingale	Saul	Nightingale	3
Pair 2	ACT	Rasika	Ranthilaka	Steve	McGregor	4
Pair 3	NSW	Anthony	Hayes	Benjamin	Collis	5
Pair 4	NSW	David	Willison	Marcus	Truppel	6
Katame No Kata						
		TORI		UKE		Rank
Pair 2	Tas	Wakamatsu	Yutaka	Mackey	Nick	1
Pair 7	NSW	Andras	Koltai	Edmund	Yuen	2
Pair 4	WA	Dawn	Santos	Paul	Kendrick	3
Pair 1	WA	Melissa	Dennehy	Dawn	Santos	4
Pair 5	WA	Paul	Malinowski	Yekaterina	Yurkova	5
Pair 6	QLD	Mathew	Kinstler	Campbell	Dunstan	6
Pair 3	VIC	Hunter	Richardson	David	Nabulsi	7
Ju No Kata						
		TORI		UKE		Rank
Pair 3	SA	Meera	Verma	Amy	Trinh	1
Pair 1	NSW	Ernie	Wakamatsu	Aurora	Ilainen	2
Pair 2	NSW	Bernard	Tandean	Bianca	Tandean	3
Kime No Kata						
		TORI		UKE		Rank
Pair 3	Qld	Geoff	Watson	Srdjan	Angelkovic	1
Pair 2	NSW	Yekaterina	Yurkova	Alexander	Malinowski	2
Pair 1	ACT	Mathew	D'Aquino	John	Watkins	3